



403 Poyntz Ave., Suite B
Manhattan, KS 66502, USA
Phone: +1-785-770-8511
Email: support@thunderheadeng.com
Web: <https://www.thunderheadeng.com>



Pathfinder Verification and Validation

Version: 2021-3
Last Modified: 2021-09-01



Table of Contents

Disclaimer	2
1. Introduction	3
1.1. Simulation Modes	3
1.2. Inertia	4
2. Fundamental Diagram Tests	5
2.1. Fundamental Diagram for Unidirectional Flow	5
2.2. Fundamental Diagram for Bidirectional Flow	10
2.3. Fundamental Diagram for Merging of Pedestrian Streams in T-Junction	17
2.4. Fundamental Diagram Customization for Stairs and Ramps	24
3. Flow Rate Tests	32
3.1. Door Flow Rates	32
3.2. Stair Flow Rates	33
3.3. Corridor Flow Rates	36
4. Behavior Tests	40
4.1. Refuge Room as Final Destination	40
4.2. Grouping Behavior	41
4.3. Corridor Merging	44
4.4. Stairway Merging	48
4.5. Passing Slow Occupants on Stairs	52
4.6. Elevator loading	54
4.7. Use of Corridor during Cornering	56
5. Special Program Features	59
5.1. Assisted Evacuation	59
5.2. Source Flow Rates	72
5.3. Fractional Effective Dose (FED) Calculation	73
5.4. Walking Speed Reduction Due to Smoke	78
5.5. Social Distancing	82
6. IMO Tests	85
6.1. Movement Speed (IMO_01)	85
6.2. Stairway Speed, Up (IMO_02)	86
6.3. Stairway Speed, Down (IMO_03)	88
6.4. Door Flow Rates (IMO_04)	89
6.5. Initial Delay Time (IMO_05)	91
6.6. Rounding Corners (IMO_06)	92

6.7. Multiple Movement Speeds (IMO_07)	94
6.8. Counterflow (IMO_08)	97
6.9. Sensitivity to Available Doors (IMO_09)	101
6.10. Exit Assignments (IMO_10)	103
6.11. Congestion (IMO_11)	105
7. NIST Evacuation Tests	111
7.1. Pre-evacuation time distributions (Verif.1.1)	111
7.2. Speed in a corridor (Verif.2.1)	111
7.3. Speed on stairs (Verif.2.2)	111
7.4. Movement around a corner (Verif.2.3)	111
7.5. Assigned demographics (Verif.2.4)	111
7.6. Reduced visibility vs walking speed (Verif.2.5)	111
7.7. Occupant incapacitation (Verif.2.6)	111
7.8. Elevator usage (Verif.2.7)	114
7.9. Horizontal counter-flows (Verif.2.8)	117
7.10. Group behaviors (Verif.2.9)	117
7.11. People with movement disabilities (Verif.2.10)	121
7.12. Exit route allocation (Verif.3.1)	124
7.13. Social influence (Verif.3.2)	125
7.14. Affiliation (Verif.3.3)	125
7.15. Dynamic availability of exits (Verif.4.1)	125
7.16. Congestion (Verif.5.1)	127
7.17. Maximum flow rates (Verif.5.2)	127
8. SFPE Example Problems	128
8.1. Example 1: Single Room and Stairway (SFPE_1)	128
8.2. Example 2: 5-Story Building (SFPE_2)	135
Bibliography	153

Disclaimer

Thunderhead Engineering makes no warranty, expressed or implied, to users of Pathfinder, and accepts no responsibility for its use. Users of Pathfinder assume sole responsibility under Federal law for determining the appropriateness of its use in any particular application; for any conclusions drawn from the results of its use; and for any actions taken or not taken as a result of analyses performed using these tools.

Users are warned that Pathfinder is intended for use only by those competent in the field of pedestrian modeling. Pathfinder is intended only to supplement the informed judgment of the qualified user. The software package is a computer model that may or may not have predictive capability when applied to a specific set of factual circumstances. Lack of accurate predictions by the model could lead to erroneous conclusions. All results should be evaluated by an informed user.

Chapter 1. Introduction

This document presents verification and validation test data for the Pathfinder simulator.

The following definitions are used throughout this document:

Verification

Test cases designed to ensure that the simulator is performing as specified by the Pathfinder Technical Reference. Usually these tests attempt to isolate specific simulated quantities or behaviors and may include only a small number of occupants. This type of test often has very specific pass/fail criteria. Verification tests ensure that the software implements a model correctly – they are not designed to measure how accurately that model reflects reality.

Validation

Test cases designed to measure how well Pathfinder’s implementation of simulation models captures real behavior. Usually these tests will explore the interaction between multiple simulation elements and may have less specific pass/fail criteria. Validation tests are usually based on experimental data or experience (e.g. congestion should form at a location).

Usage of the terms *Verification* and *Validation* in this document is consistent with the terminology presented in IEEE Standard 1012 (“[IEEE 1012-2016 - IEEE Standard for System, Software, and Hardware Verification and Validation](#)” 2016) and ISO 16730-1 (“[ISO 16730-1:2015E - Fire Safety Engineering — Procedures and Requirements for Verification and Validation of Calculation Methods](#)” 2015).

NOTE

Previous versions of this document prior to the 2020.1 release of Pathfinder can be found on the [Pathfinder Verification and Validation Archive](#) page.

1.1. Simulation Modes

Most test cases in this chapter are executed using three different configurations (modes) based on the **Behavior Mode** option and the **Limit Door Flow Rate** option in Pathfinder’s **Simulation Parameters** dialog.

- A **Steering** simulation is run with a **Behavior Mode** selection of **Steering**. This is the default Pathfinder behavior and all occupants use a steering system to move and interact with others, there are no specified flow rates.
- An **SFPE** simulation is run with a **Behavior Mode** selection of **SFPE**. In SFPE mode, occupants make no attempt to avoid one another and can interpenetrate, but doors impose a flow limit and velocity is controlled by density.
- A **Steering+SFPE** simulation is run with a **Behavior Mode** selection of **Steering** and **Limit**

Door Flow Rate active. The occupants use a steering system to move, but flow rates through doors are limited to the SFPE values.

In each case, all other simulator options are left at the default setting unless otherwise specified. For cases that examine speed-density behavior, only the **Steering** mode is applicable.

1.2. Inertia

The SFPE mode supported by Pathfinder allows occupants to instantly transition between speeds without accounting for acceleration. However, when predicting the results for simulations run using the **Steering** mode, it is necessary to account for inertia.

Assuming an occupant must travel some distance [stem 2103f85b8b1477f430fc407cad462224], this is generally done in the following way:

1. Calculate [stem 2d271e1ad2177e42a29ecdd6e3d41cf8] using the following equation of motion: [stem 1f56771b66bea938023c68aec4126d5c] where [stem 2d271e1ad2177e42a29ecdd6e3d41cf8] is the distance traveled, [stem 5c47a1e7d40f282bd3025910aa9b694c] is the initial velocity, [stem c6f4d121f6844ba60d2aab48f36aad05] is the final velocity, and [stem 78e95e0d458b1115649366ef4e2feb10] is the time it takes to transition from [stem 5c47a1e7d40f282bd3025910aa9b694c] to [stem c6f4d121f6844ba60d2aab48f36aad05]. In Pathfinder, the default acceleration is calculated to allow occupants to transition from being motionless to traveling at maximum velocity in **1.1 seconds**. [stem 5c47a1e7d40f282bd3025910aa9b694c] is generally zero and [stem c6f4d121f6844ba60d2aab48f36aad05] is the occupant's maximum velocity.
2. Calculate [stem 07abbc0c079d42c8cdd342d2457ff639] as the remaining distance that needs to be traveled: [stem 6ed2c2690333ae12b338a2f7292d7f6e].
3. Calculate the time [stem cdf43ad0366b98bad8d28d8dc150f925] needed to travel the remaining distance, [stem 07abbc0c079d42c8cdd342d2457ff639], using the equation: [stem 166a408ecef23a395fd25efd41fd4c].
4. The full time [stem 4f4f4e395762a3af4575de74c019ebb5] needed to accelerate from **0.0 m/s** and walk distance [stem 2103f85b8b1477f430fc407cad462224] is then given by: [stem 8dddf52139f27f462d8b72f49a68dac4].

Inertia also impacts the effective flow rates through the doors for the *Steering+SFPE* mode, since each occupant must accelerate when released to pass through the door.

Chapter 2. Fundamental Diagram Tests

In Pathfinder, the user can specify a Speed-Density Profile – the *fundamental diagram*. Since occupants can have different individual walking speeds, the user defines a normalized profile. The speed-density profile for that occupant is obtained by multiplying that occupant's speed by the normalized speed-density profile (Figure 1). The default normalized speed-density profile corresponds to the SFPE specification (SFPE 2019) with the modification that, at high densities, the speed goes to a factor of 0.15 rather than zero.

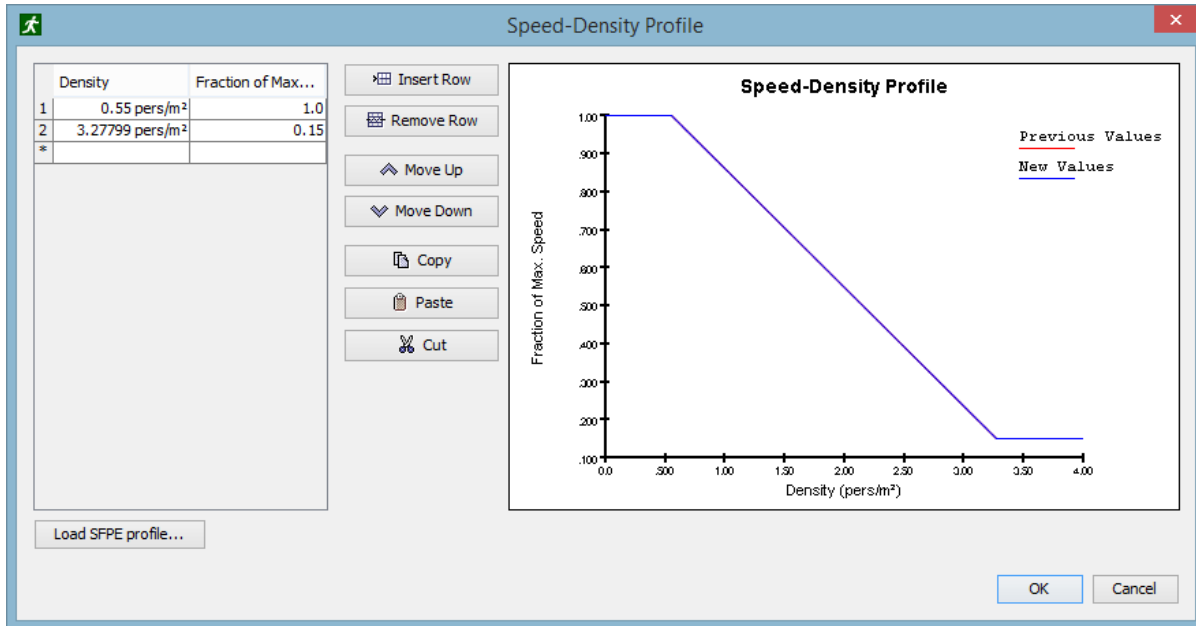

Figure 1. The default SFPE Speed-Density Profile

2.1. Fundamental Diagram for Unidirectional Flow

2.1.1. Background

"Transitions in pedestrian fundamental diagrams of straight corridors and T-junctions" (Zhang et al. 2011), "Ordering in bidirectional pedestrian flows and its influence on the fundamental diagram" (Zhang et al. 2011) and "Empirical Characteristics of Different Types of Pedestrian Streams" (Zhang and Seyfried 2013) describe a series of experiments in which they measured the fundamental diagram by controlling density in a corridor by varying the entrance and exit widths (Figure 2).

You can download the actual experimental videos and supporting documentation from the [Pedestrian Dynamics Data Archive](#).

This validation case will focus on the unidirectional flow results.

A summary of the experimental results for unidirectional and bidirectional flows is shown in [Figure 3](#). The corresponding SFPE specification curves are shown in [Figure 4](#). Compared to the SFPE calculations, the Zhang and Seyfried experiments have a higher occupant speed (measured free velocity of 1.55 ± 0.18 m/s) and a significantly higher measured specific flow (although the paper notes large specific flow variations for small changes in the experimental setup for densities greater than 2 pers/m²).

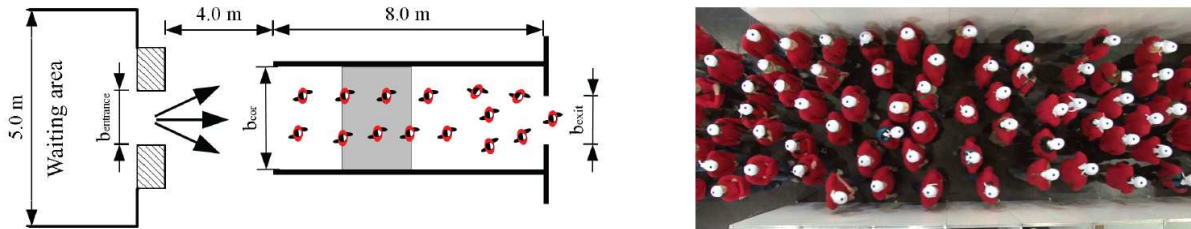

Figure 2. Setup and snapshot of unidirectional flow experiment. The gray area in the sketch shows the location of measurement area (Zhang and Seyfried 2013).

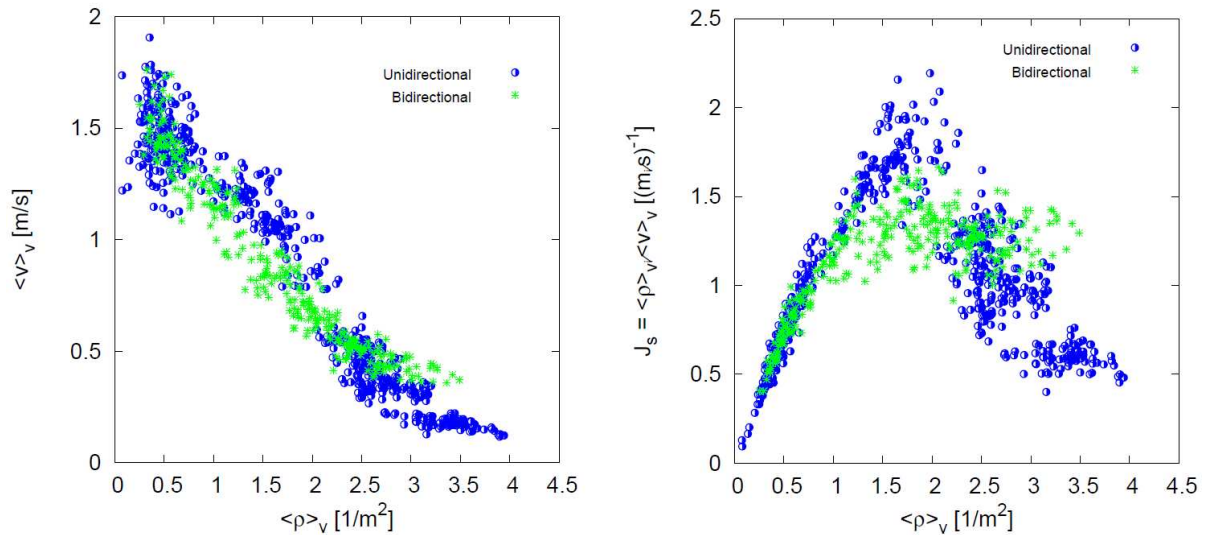

Figure 3. Comparison of the fundamental diagrams between uni- and bidirectional pedestrian flow (Zhang and Seyfried 2013).

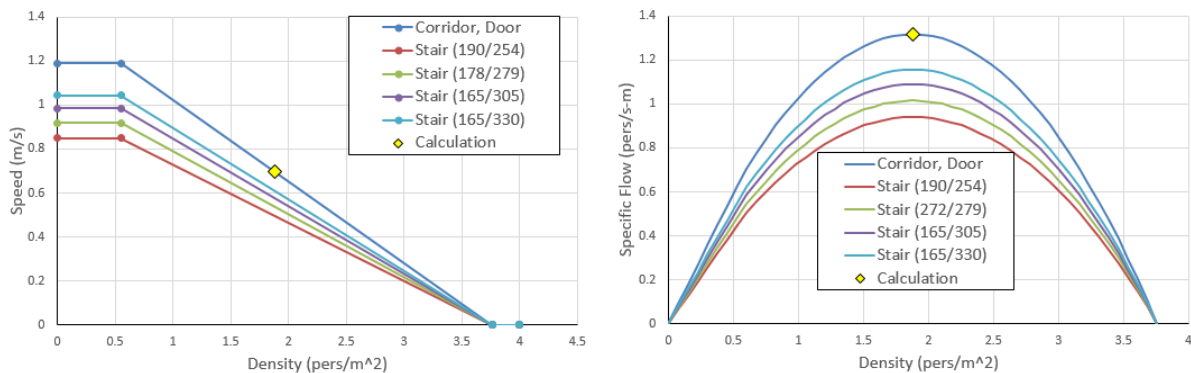

Figure 4. SFPE fundamental diagrams

2.1.2. Setup Notes

The Pathfinder model is shown in [Figure 5](#). This model is a subset of the experiments reported in "Transitions in pedestrian fundamental diagrams of straight corridors and T-junctions" ([Zhang et al. 2011](#)). The Pathfinder model uses a 3 m corridor. For six cases the entrance width varied from 2 m to 3 m with the exit width held constant at 3 m (these are low density cases) followed by 10 cases where the entrance width was held constant at 3 m and the exit width varied from 3 m to 1 m (high density cases). The red rectangles indicate the regions used to measure the speed-density results. To ensure steady-state results, 1000 people were used for each case.

The sixteen cases were repeated for three walking speed assumptions:

1. The Zhang and Seyfried values of 1.55 ± 0.18 m/s with the speed profile shown in [Figure 6](#) (which represents the experimental speed-density data shown in [Figure 3](#)).
2. A constant speed of 1.19 m/s with the SFPE speed-density relationship ([Figure 1](#)).
3. A uniform speed distribution 1.19 ± 0.25 m/s, with the with the SFPE speed-density relationship ([Figure 1](#)).

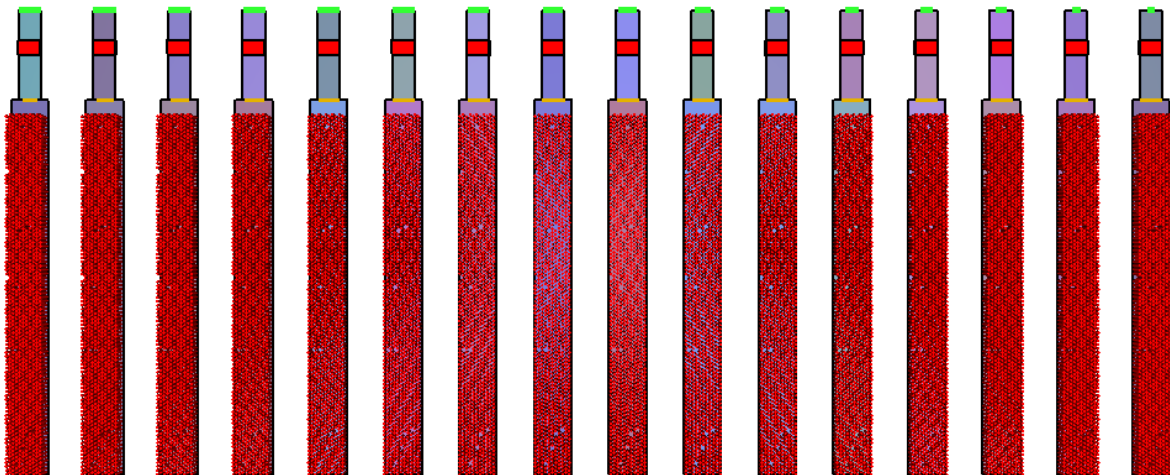

Figure 5. Pathfinder model for Zhang and Seyfried unidirectional experiments.

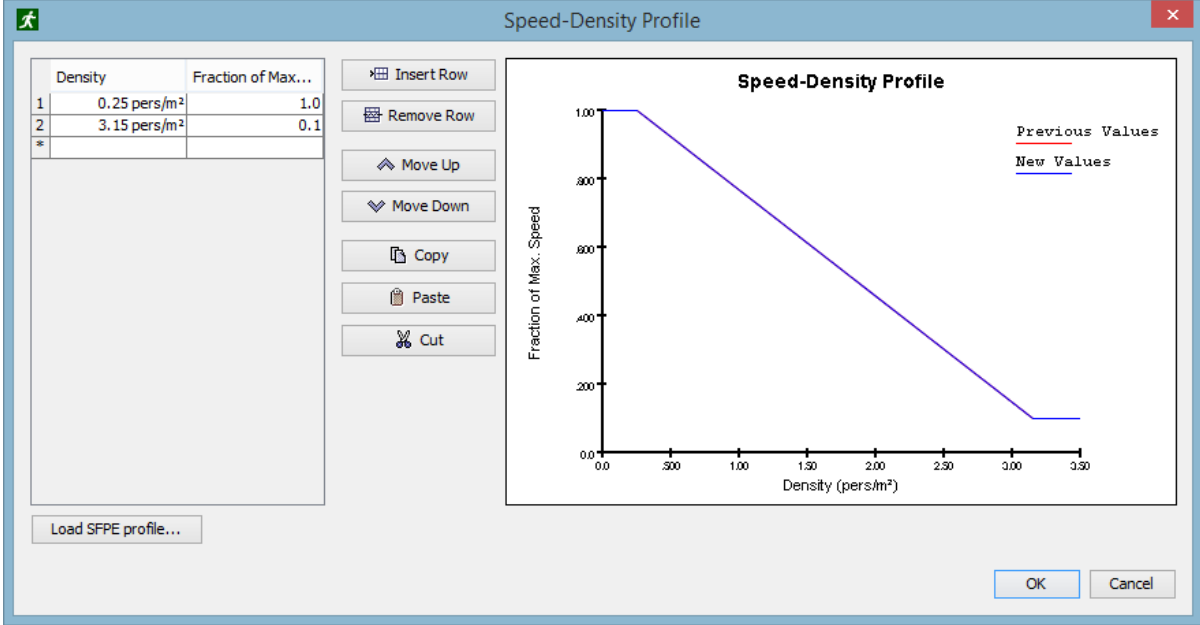

Figure 6. The input corresponding to the experimental Zhang and Seyfried Speed-Density Profile

2.1.3. Results

Speed-density and specific flow-density results for the Zhang and Seyfried experiment are presented for each of the three cases. In these curves, the data is presented over time intervals when "steady-state" conditions have been reached. The gray points represent all the calculated speed-density pairs for all corridors.

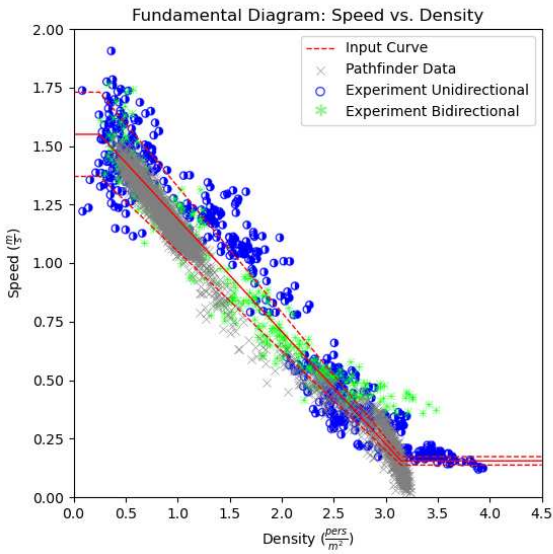

Figure 7. Speed-Density results with measured speed-density input and uniform velocity distribution 1.55 ± 0.18 m/s.

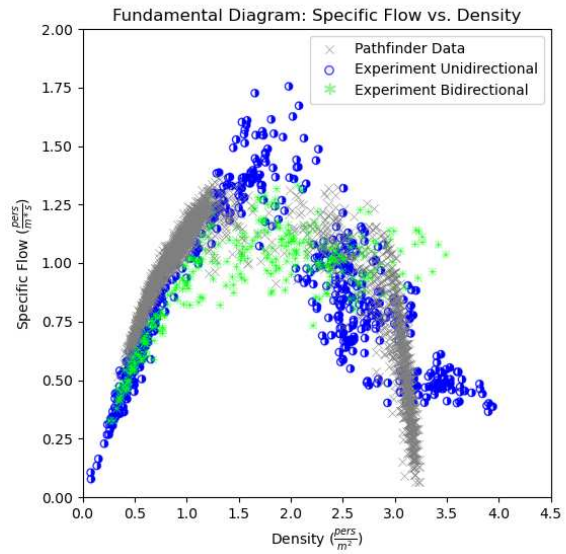

Figure 8. Specific Flow-Density results with measured speed-density input and uniform velocity distribution 1.55 ± 0.18 m/s.

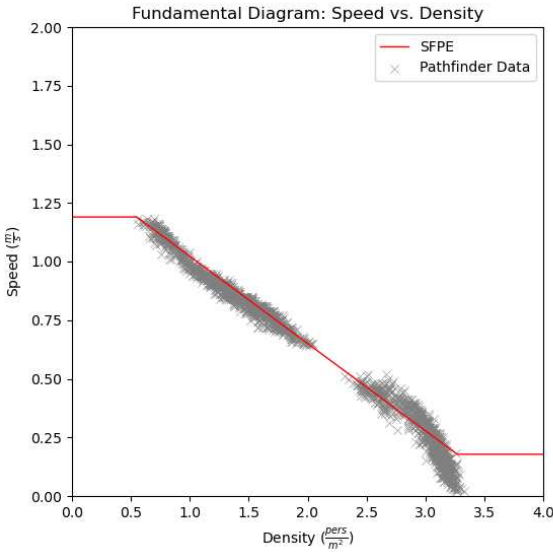

Figure 9. Speed-Density results with SFPE speed-density input and constant velocity 1.19 m/s.

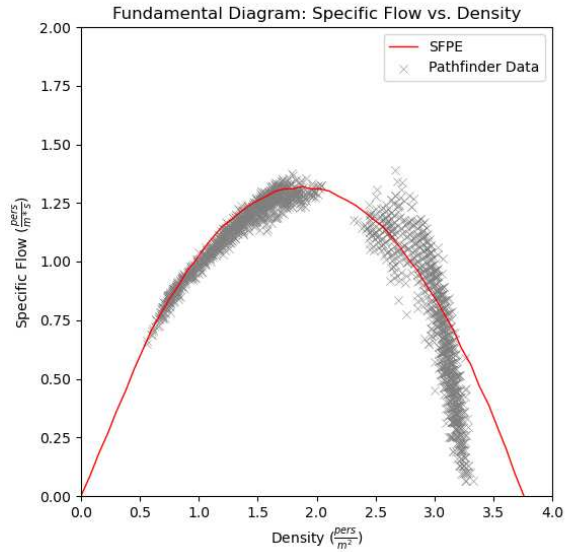

Figure 10. Specific Flow-Density results with SFPE speed-density input and constant velocity 1.19 m/s.

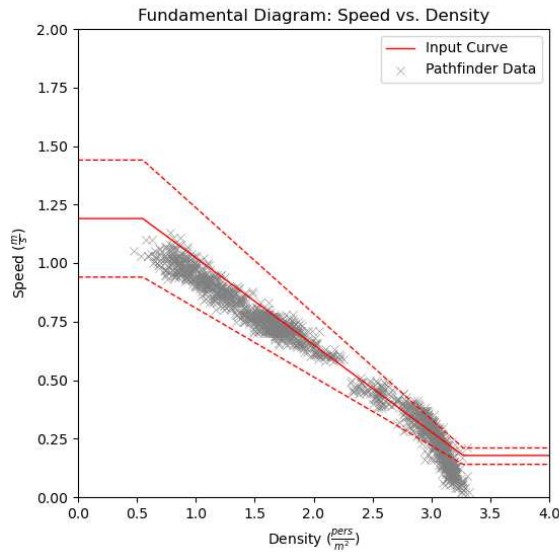

Figure 11. Speed-Density results with SFPE speed-density input and uniform velocity distribution 1.19 ± 0.25 m/s.

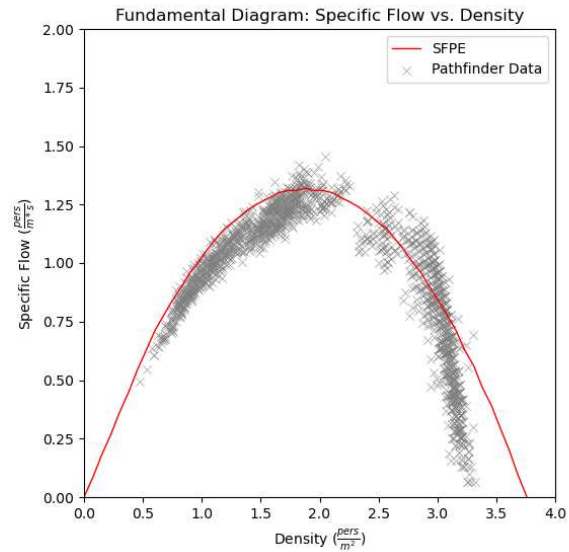

Figure 12. Specific Flow-Density results with SFPE speed-density input and uniform velocity distribution 1.19 ± 0.25 m/s.

2.1.4. Analysis

The Pathfinder calculations replicate the input speed-density curve. The calculated points are slightly below the input curves, making the results slightly conservative. The specific flow calculations also match the expected results. The comparisons show that Pathfinder correctly uses the input speed-density curve in the calculations.

2.2. Fundamental Diagram for Bidirectional Flow

2.2.1. Background

In addition to unidirectional flow, Zhang and Seyfried (Zhang and Seyfried 2013) and Zhang, Klingsch, Schadschneider, and Seyfried (Zhang et al. 2011) describe experimental results for bidirectional flow. The experimental bidirectional results are summarized and compared to unidirectional results in Figure 3.

The experimental setup is shown in Figure 13. For a Balanced Flow Ratio (BFR) the left and right entrance widths were identical. A limited number of tests used an Unbalanced Flow Ratio (UFR) with different entrance widths. The measured fundamental diagrams were the same for balanced and unbalanced flow.

In addition, participants were either allowed to select to exit to their left or right or were assigned

a direction. When the participants selected the exit direction, Stable Separated Lanes (SSL) formed, but when required to exit a given direction, lanes were unstable and varied in time and space (Figure 14) resulting in Dynamical Multi-Lanes (DML) flow.

Figure 15 and Figure 16 show the parameters for the experiments.

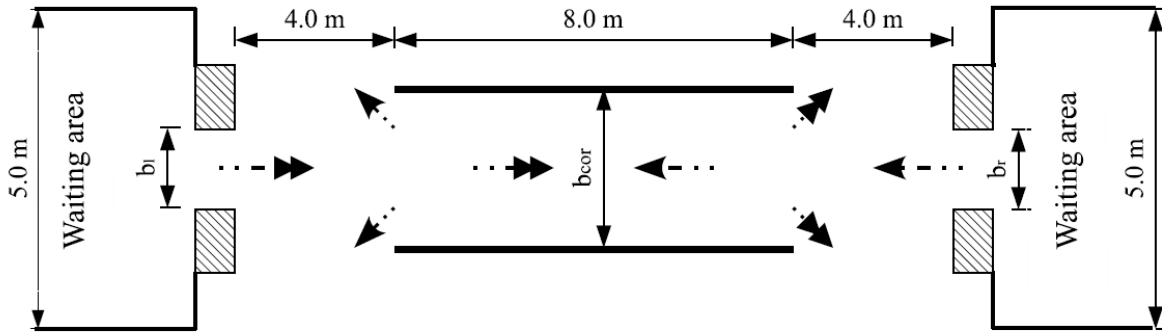

Figure 13. Setup and of bidirectional flow experiment. The widths of the corridor, left entrance, and right entrance were varied in the experiment (Zhang and Seyfried 2013).

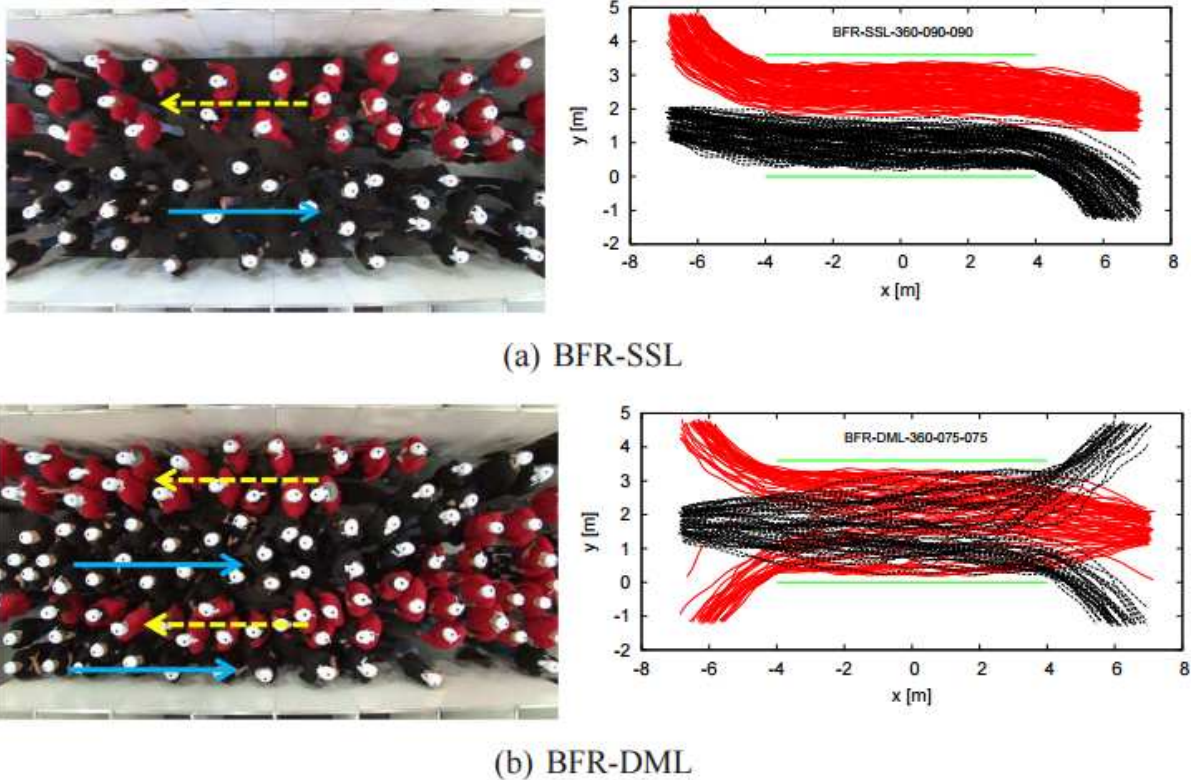

Figure 14. Bidirectional flow images for the case with an equal number of left and right participants (Balanced Flow Ratio – BFR). Stable Separated Lanes (SSL) form when participants can select the exit direction, Dynamical Multi-Lanes (DML) form when and each participant is assigned to exit either to their left or right. For the DML case lanes are unstable and vary in time and space. (Zhang and Seyfried 2013).

Index	Name	b_{cor} [m]	b_l [m]	b_r [m]	N_l	N_r
1	BFR-SSL-360-050-050	3.60	0.50	0.50	57	61
2	BFR-SSL-360-075-075	3.60	0.75	0.75	56	80
3	BFR-SSL-360-090-090	3.60	0.90	0.90	109	105
4	BFR-SSL-360-120-120	3.60	1.20	1.20	143	164
5	BFR-SSL-360-160-160	3.60	1.60	1.60	143	166

Figure 15. Table of the experimental parameters used for the Balanced Flow Ratio (BFR) and participant selected exits Stable Separated Lanes (SSL) experiments (Zhang and Seyfried 2013).

Index	Name	b_{cor} [m]	b_l [m]	b_r [m]	N_l	N_r
1	BFR-DML-300-050-050	3.00	0.50	0.50	54	71
2	BFR-DML-300-065-065	3.00	0.65	0.65	64	83
3	BFR-DML-300-075-075	3.00	0.75	0.75	61	86
4	BFR-DML-300-085-085	3.00	0.85	0.85	119	97
5	BFR-DML-300-100-100	3.00	1.00	1.00	125	105
6	BFR-DML-360-050-050	3.60	0.50	0.50	56	74
7	BFR-DML-360-075-075	3.60	0.75	0.75	62	65
8	BFR-DML-360-090-090	3.60	0.90	0.90	110	102
9	BFR-DML-360-120-120	3.60	1.20	1.20	115	106
10	BFR-DML-360-160-160	3.60	1.60	1.60	140	166
11	BFR-DML-360-200-200	3.60	2.00	2.00	143	166
12	BFR-DML-360-250-250	3.60	2.50	2.50	141	163

Figure 16. Table of the experimental parameters used for the Balanced Flow Ratio (BFR) and assigned exits Dynamical Multi-Lane (DML) experiments (Zhang and Seyfried 2013).

You can download the actual experimental videos and supporting documentation at this link, [Pedestrian Dynamics Data Archive](#).

This validation case will focus on bidirectional flow results.

2.2.2. Setup Notes

Pathfinder models were used to simulate the experimental cases with a 3.6 m wide corridor. The BFR-SSL model is shown in Figure 17. The widths of the two entry doors are always identical to each other, but the door widths change to control the density. The red rectangles indicate the regions used to measure the speed-density results. The measured experimental entry flow rates were used to specify the source time histories and the **Enforce Flow Rate** option was used.

For all cases, the measured walking speed of 1.55 ± 0.18 m/s was used with a speed profile that corresponds to the unidirectional speed-density data shown in Figure 6. We did not modify the

speed-density profile for different problems, but use the unidirectional speed-density data for all cases. The intent is that the movement algorithm should adjust for different situations.

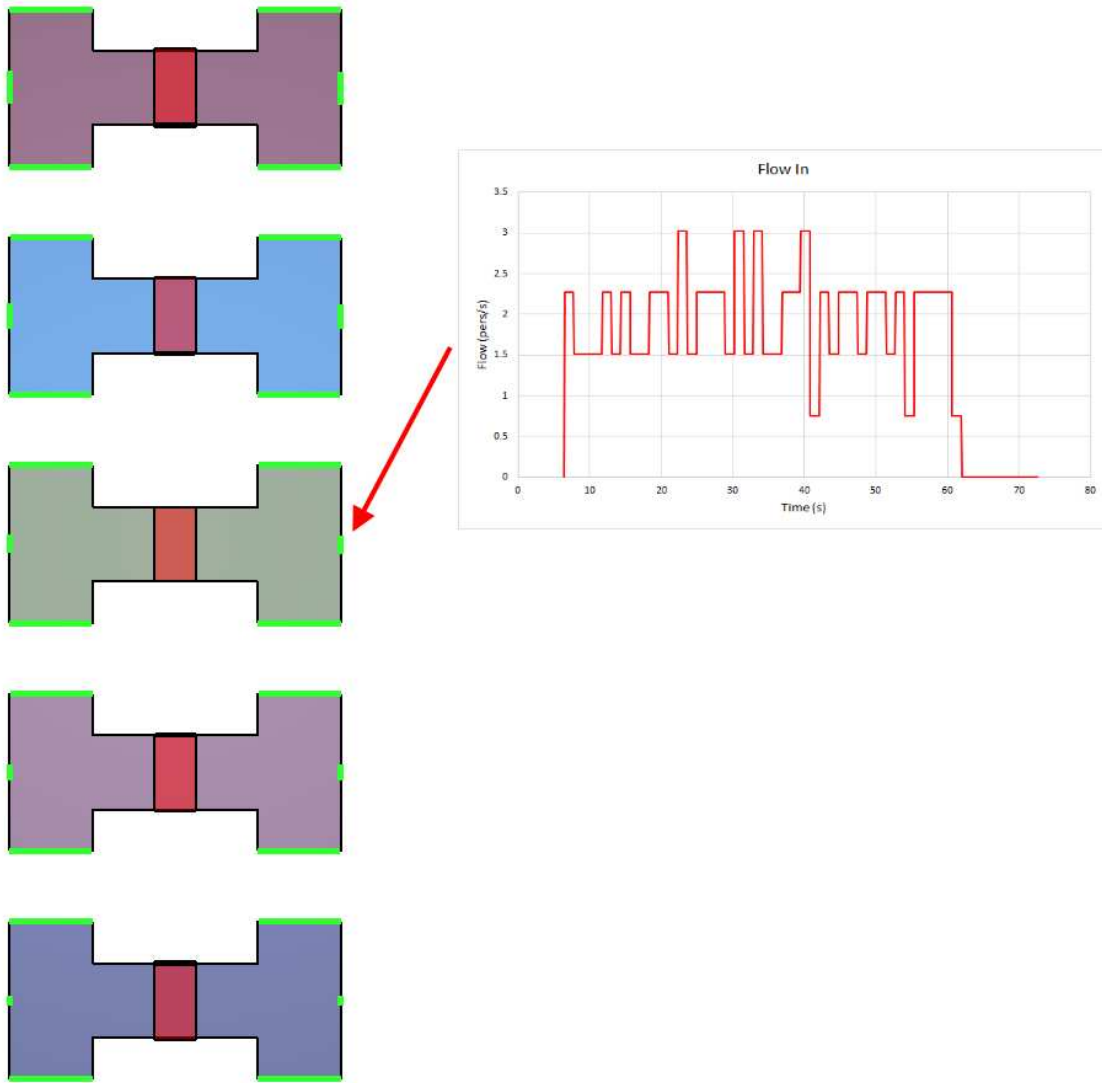

Figure 17. Pathfinder model for bidirectional flow.

In Figure 17, the measured experimental entry flow rates are used to specify the input flows in the model. This model shows the BFR-SSL experiments, a similar model was used for the BFR-DML cases.

2.2.3. Results for Balanced Flow Ratio (BFR) and participant selected exits Stable Separated Lanes (SSL)

Speed-density and specific flow-density results are presented in Figure 18 and Figure 19. In these curves, the data is presented over time intervals when "steady-state" conditions have been

reached. The gray points represent all the calculated speed-density pairs for all corridors.

Figure 20 and Figure 21 provide a comparison of experimentally observed and calculated occupant paths at 50 seconds, 1.6 m entry width, free choice of destination. As shown in Figure 14 (a) and Figure 20, in the experiment occupants separated into separate lanes and maintained that separation throughout the experiment. Occupants exited through only the corridor door on the side of their lane. In Pathfinder, lanes form, but they are dynamic and occupants exit on both corridor doors.

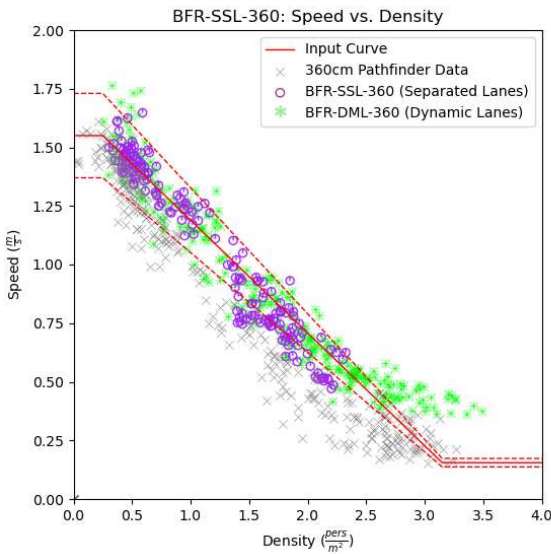

Figure 18. Speed-Density results with free choice destination, unidirectional speed-density input, and uniform velocity distribution 1.55 ± 0.18 m/s.

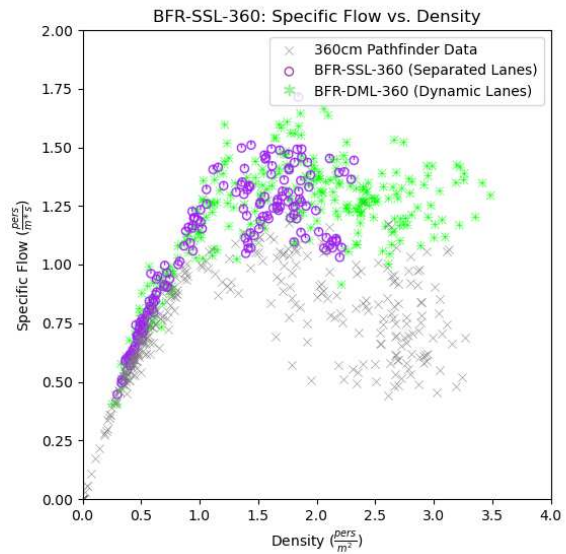

Figure 19. Specific Flow-Density results with free choice destination, unidirectional speed-density input, and uniform velocity distribution 1.55 ± 0.18 m/s.



Figure 20. BFR-DDL-360-160-160 Experimental image

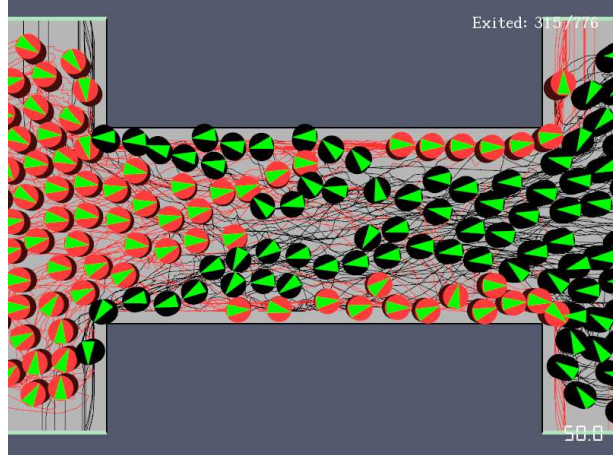

Figure 21. Pathfinder showing occupant paths

2.2.4. Results for Balanced Flow Ratio (BFR) and assigned exits Dynamical Multi-Lane (DML)

Speed-density and specific flow-density results are presented for each of the three walking speed cases in [Figure 22](#) and [Figure 23](#). In these curves, the data is presented over time intervals when "steady-state" conditions have been reached. The gray points represent all the calculated speed-density pairs for all corridors, while the black points are the averaged values for each corridor.

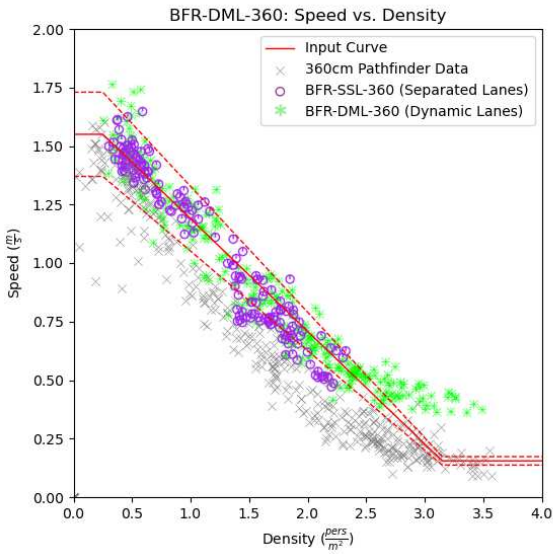

Figure 22. Speed-Density results with assigned destination, unidirectional speed-density input, and uniform velocity distribution 1.55 ± 0.18 m/s.

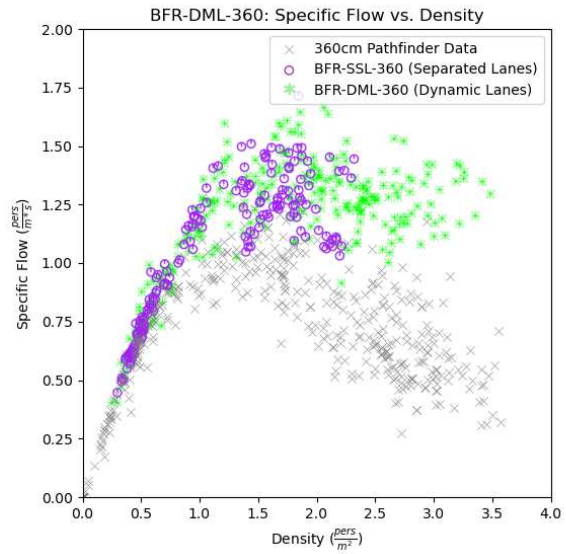

Figure 23. Specific Flow-Density results with assigned destination, unidirectional speed-density input, and uniform velocity distribution 1.55 ± 0.18 m/s.

Figure 24 and Figure 25 provide a comparison of experimental and Pathfinder results at 30 seconds, 1.6 m entry width, assigned destination.



Figure 24. BFR-DML-360-160-160 Experimental image

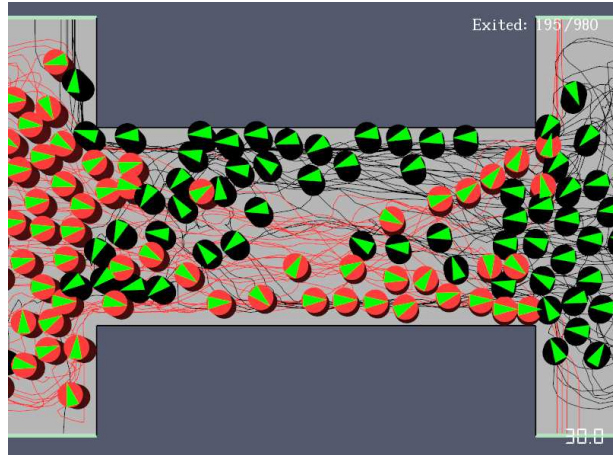

Figure 25. Pathfinder showing occupant paths

2.2.5. Analysis

Pathfinder includes only a simple lane-forming algorithm, so it does not replicate the ordered paths shown in Figure 14. Instead, the occupants tend to cross paths more frequently. As a result,

for a given speed the calculated speed-density relationship and specific flow fall below the experimental data. At high densities, both can be reduced by factors of two or more.

We can explore this further by looking at the times for all occupants to pass through the corridor. [Table 1](#) shows the corridor residence times calculated by subtracting the time the first occupant enters the corridor from the time the last occupant exits the corridor. As can be seen, at low densities the Pathfinder results are similar to experimental results. However, at high densities the Pathfinder residence times increase significantly.

This may be considered a conservative, non-optimal result.

Table 1. Comparison of experimental and Pathfinder occupant times in corridor. Experimental t_{exp} and Pathfinder t_{path} . As density increases, Pathfinder counterflow movement slows more than experimentally observed.

Case	t_{exp}	t_{path}	t_{path}/t_{exp}
BFR-SSL: Balanced Flow Ratio - Stable Separated Lanes			
bo-360-050-050	57.0	70.47	1.24
bo-360-075-075	67.1	74.75	1.11
bo-360-090-090	61.7	110.42	1.79
bo-360-120-120	78.0	197.53	2.53
bo-360-160-160	77.2	180.50	2.34
BFR-DML: Balanced Flow Ratio - Dynamical Multi-Lane			
bot-360-050-050	66.7	76.95	1.15
bot-360-075-075	50.5	64.40	1.28
bot-360-090-090	63.1	101.20	1.6
bot-360-120-120	80.0	171.60	2.15
bot-360-160-160	76.5	189.07	2.47
bot-360-200-200	73.9	183.72	2.49
bot-360-250-250	72.2	194.85	2.7

2.3. Fundamental Diagram for Merging of Pedestrian Streams in T-Junction

2.3.1. Background

A series of experiments were performed to measure the fundamental diagram for turning and merging of pedestrian streams in T-junction (Zhang et al. 2011) (Figure 26). The corridor width was 2.4 m and density was controlled by using different widths of the entrance (from 0.5 m to 2.4 m), which is 4 m away from the corridor. A summary of the results for unidirectional and bidirectional flows is shown in Figure 28.

The Zhang et al. experiments have an occupant speed of 1.55 ± 0.18 m/s. As can be seen, the fundamental diagrams in front of the T-junction are different that the behind the junction. The authors state "However, we cannot conclude whether the merging behavior itself or the congestions caused by it lead to the difference at present."

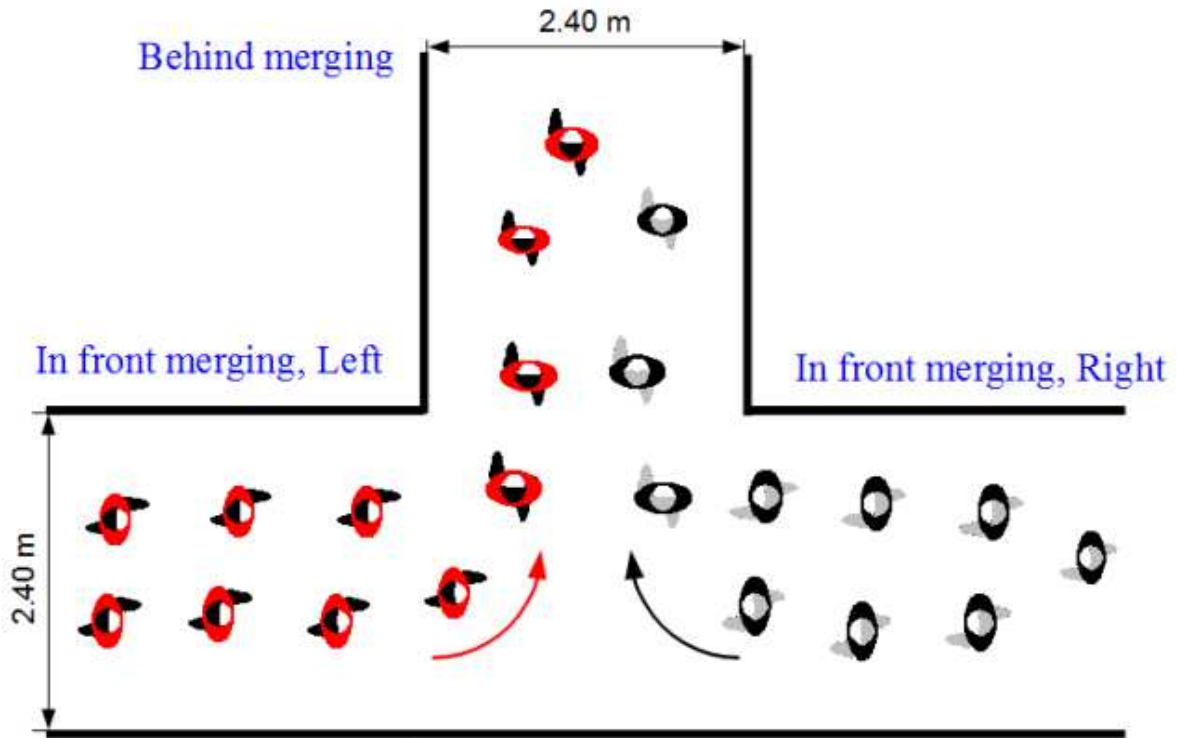

Figure 26. T-junction experiment sketch and image (Zhang and Seyfried 2013).

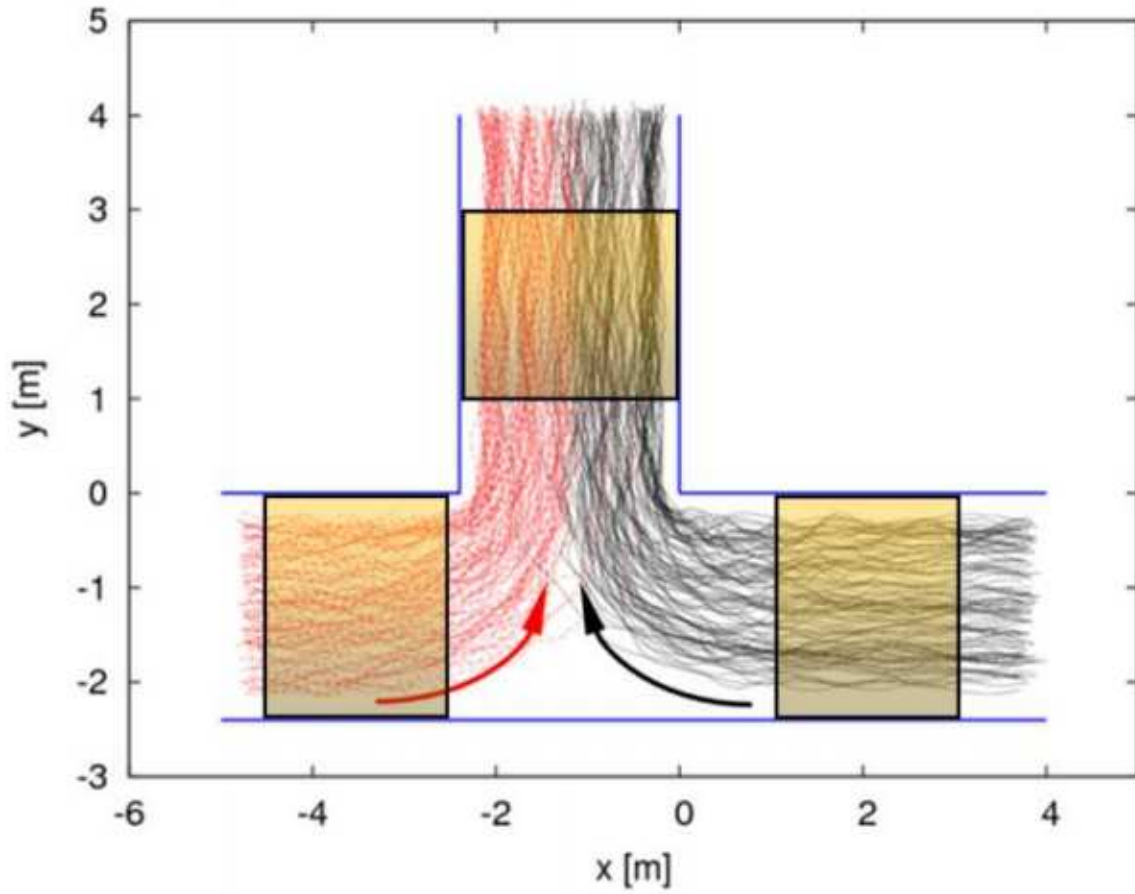

Figure 27. Pathfinder showing occupant paths and locations used to calculate density.

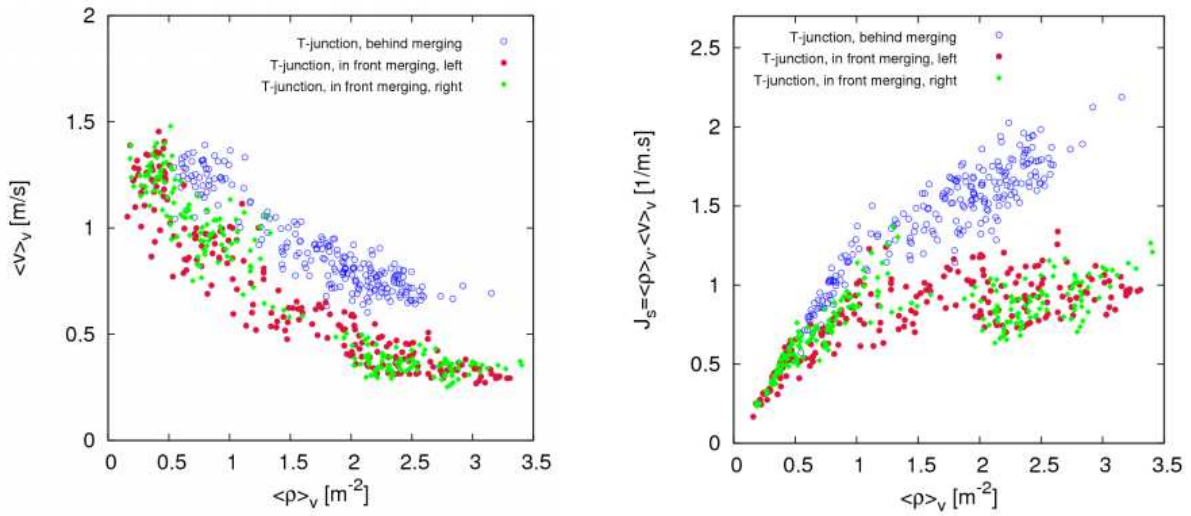

Figure 28. Fundamental diagrams for T-junction (Zhang and Seyfried 2013).

2.3.2. Setup Notes

The corresponding Pathfinder model is shown in [Figure 29](#). The paper does not provide the exact values of entrance widths to the 2.4 m corridor, so the Pathfinder calculation assumed five cases where the entrance widths were 0.5 m, 1.0 m, 1.5 m, 2.0 m, 2.4 m.

The five cases used the Zhang and Seyfried values of 1.55 ± 0.18 m/s with a speed profile that corresponds to the speed-density data shown in [Figure 3](#). This input curve is shown in [Figure 6](#). Thus, we used the same speed-density curve for our calculations as was determined based on the independent unidirectional flow experiments. We did not try to adjust the speed-density curve for the T-junction calculations. This curve results in a maximum specific flow of 1.45 pers/s-m at a density of 1.736 pers/m² and speed of 0.835 m/s.

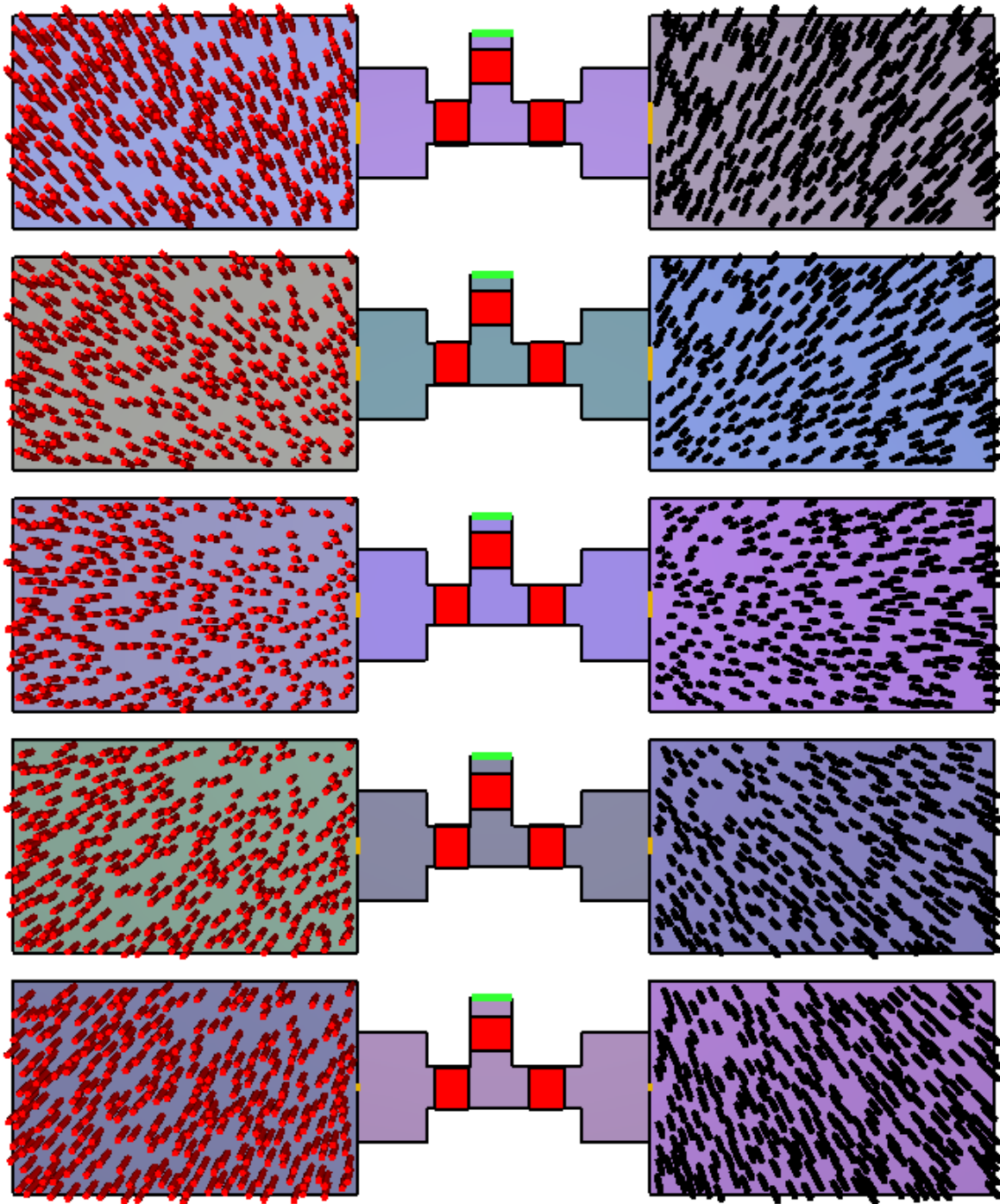

Figure 29. Pathfinder model for Zhang et al. T-junction experiments

2.3.3. Results

Speed-density and specific flow-density results are presented in [Figure 30](#) and [Figure 31](#). The data is presented over time intervals when "steady-state" conditions have been reached. The calculated points for the in front measurements tend to either lie at low densities (0.0 to 0.5 pers/m²) or at

higher densities (2 to 3 pers/m²). The reason is that for the smaller entrance cases (0.5 m and 1.0 m width entry doors), no queues develop and so the densities stay low. However, when the entrances are larger (1.5 m to 2.4 m), then the supply flow is larger than can be supported by the exit width, so queues form. The queues cause the higher densities.

As previously mentioned, the specified speed-density profile was based on the unidirectional flow experiments. As can be seen, the behind data (and most of the in front data) lie on the specified curve.

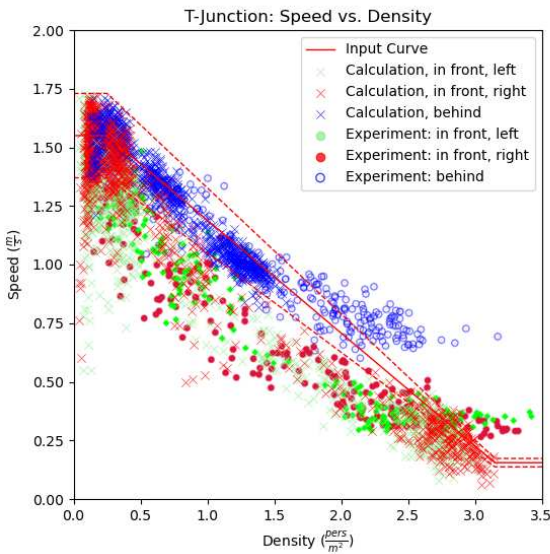

Figure 30. Speed-Density results with measured speed-density input and uniform velocity distribution 1.55 ± 0.18 m/s.

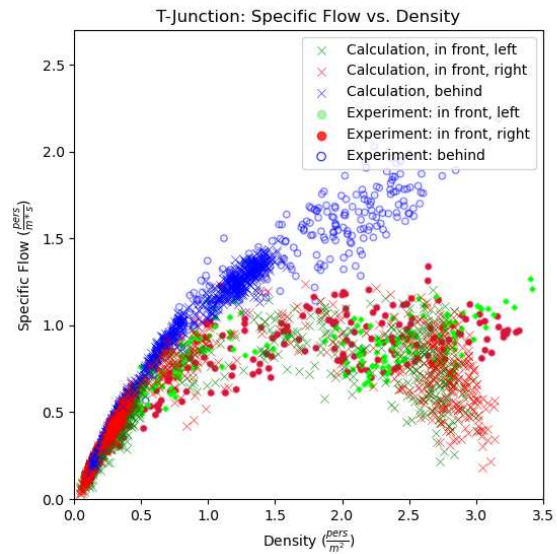

Figure 31. Specific Flow-Density results with measured speed-density input and uniform velocity distribution 1.55 ± 0.18 m/s.

2.3.4. Analysis

The Pathfinder calculations replicate the input speed-density curve. For the experiments, the measured "behind" data was similar to the unidirectional experimental data. However, the "in front" data had lower speeds for a given density. The Pathfinder results show the same effect. This is likely due to merging and turning behavior as the streams merge.

In general, the Pathfinder results match the experimental data satisfactorily. It is important to remember that we used a speed-density relationship based on unidirectional data. We did not modify the curve to better match the experimental results, so Pathfinder captures the measured differences between the "behind" data and the "in front" data.

2.4. Fundamental Diagram Customization for Stairs and Ramps

2.4.1. Background

Pathfinder allows the user to define customized fundamental diagrams for movement up and down stairs and ramps. These are defined in the profiles, so now it is possible for each profile to have five fundamental diagrams (level, stairs up, stairs down, ramp up, ramp down) with different nominal speeds for each case (including the possibility of different distributions). While potentially complex, this gives required flexibility to meet evacuation calculation standards required in some jurisdictions.

In this verification example, we will use one profile and define five different fundamental diagrams. The fundamental diagrams will correspond to the Russian evacuation code mobility profiles (M1-M4), shown in [Figure 32](#).

In the Russian standards there are 4 types of person:

M1 – healthy person

M2 – older person or blind person or other disabled person

M3 – person with crutches

M4 – person in wheelchair

Speed depends of occupants' density:

[stem 5a4a6d9bdca4cf9c3b3e6972ea285f2a]

[stem 422dd47e7ea60e02cb375e5fb019a0f6], [stem cbf8d6cb9c25c5e3a0be7cadfda49291]

Where:

[stem 2bf342cad18417d618948b612f7ca7d9] is person speed.

[stem 16cbc3c5a27d692a02ca3454c3948723] is maximum velocity. People go with [stem 16cbc3c5a27d692a02ca3454c3948723] if nobody has influence on them.

D is occupant density (m^2/m^2) or fraction of occupied area.

[stem 53ec6ab7cc31b1806d5389cd13971a5a]

Where:

N is number of people in area

f is area occupied by a person, m^2

S is the area, m^2

Type of person	f (m ²)	Parameter	Type of path				
			Room	Stair down	Stair up	Ramp down	Ramp up
M1	0.1 or 0.125	V ₀ (m/min)	100	100	60	115	80
		D ₀ (m ² /m ²)	0.051	0.089	0.067	0.171	0.107
		a	0.295	0.4	0.305	0.399	0.399
M2	0.2	V ₀ (m/min)	30	30	20	45	25
		D ₀ (m ² /m ²)	0.135	0.139	0.126	0.171	0.146
		a	0.335	0.346	0.348	0.438	0.384
M3	0.3	V ₀ (m/min)	70	20	25	105	55
		D ₀ (m ² /m ²)	0.102	0.208	0.12	0.122	0.136
		a	0.35	0.454	0.347	0.416	0.446
M4	0.96	V ₀ (m/min)	60	—	—	115	40
		D ₀ (m ² /m ²)	0.135	—	—	0.146	0.15
		a	0.4	—	—	0.424	0.42

Figure 32. Parameters for Russian speed-density relationship

For the healthy population (M1), the calculated fundamental diagrams are shown in Figure 33.

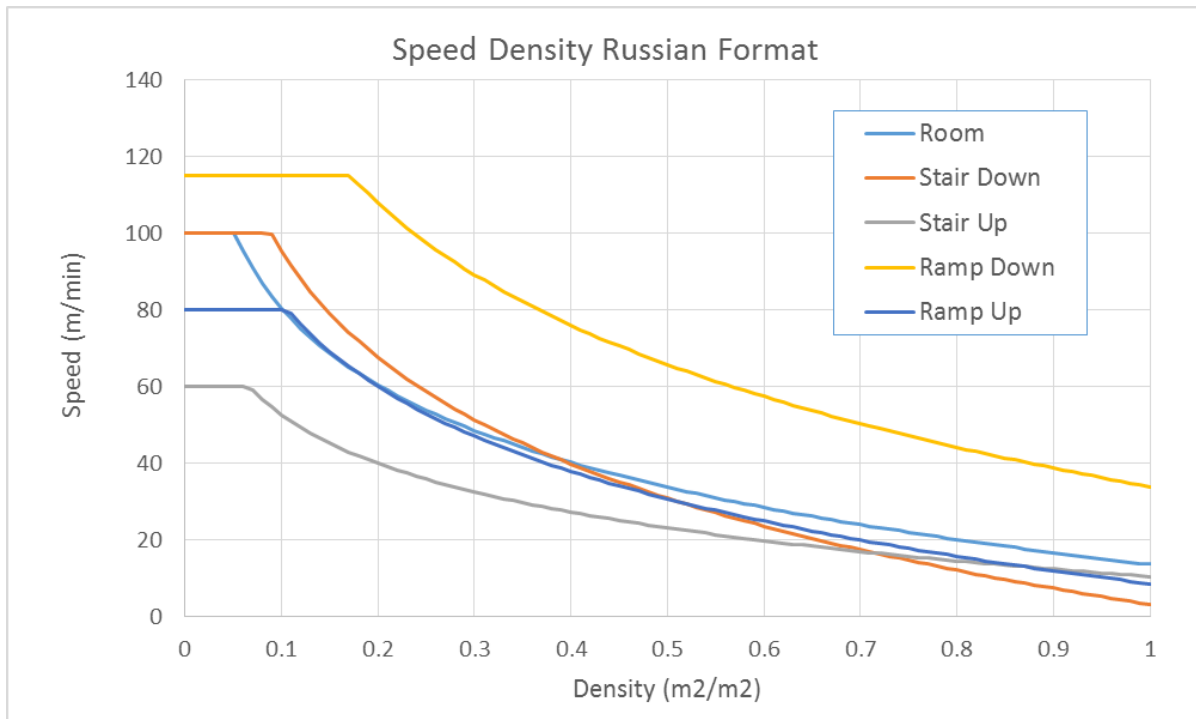

Figure 33. Fundamental diagrams for Russian healthy population

2.4.2. Setup Notes

Pathfinder models were used to simulate the Russian evacuation code for healthy people with a 0.1 m^2 area for each person. Five models were used, corresponding to level walking, stairs up, stairs down, ramp up, ramp down. Because we are not replicating a specific set of experiments, we used room sources to supply the occupants.

The level model is shown in [Figure 35](#), the sources are the rooms on the left and the occupants exit to the right. The sources introduce occupants to the model, the red squares indicate where speed-density is measured, and the occupants exit on the right. To control the densities, the source rate of the entry room and the flow rates of the exit doors were specified, as shown in [Figure 34](#).

The values are different for different cases since the speed-density curves are different and different flow rates can be maintained. Similar models were used for stairs and ramps.

Source and Exit Flow Rates (pers/s)									
Level		Stair Down		Stair Up		Ramp Down		Ramp Up	
Source Flow	Hall Exit Rate	Source Flow	Stair Exit Rate	Source Flow	Stair Exit Rate	Source Flow	Ramp Exit Rate	Source Flow	Ramp Exit Rate
3.00	6.00	3.00	6.00	1.00	6.00	4.00	Open	3.00	6.00
4.00	6.00	4.00	6.00	3.00	6.00	8.00	Open	4.00	6.00
5.00	6.00	5.00	6.00	4.00	6.00	12.00	Open	5.00	6.00
6.00	6.00	6.00	6.00	5.00	6.00	16.00	Open	6.00	6.00
6.25	6.00	6.50	6.00	6.00	6.00	20.00	Open	6.50	6.00
6.50	6.00	7.00	6.00	6.50	6.00	24.00	Open	7.00	6.00
6.75	6.00	7.50	6.00	7.00	6.00	28.00	Open	7.50	6.00
7.00	6.00	8.00	6.00	7.50	6.00	32.00	Open	8.00	6.00

Figure 34. Flow rates of sources and exits

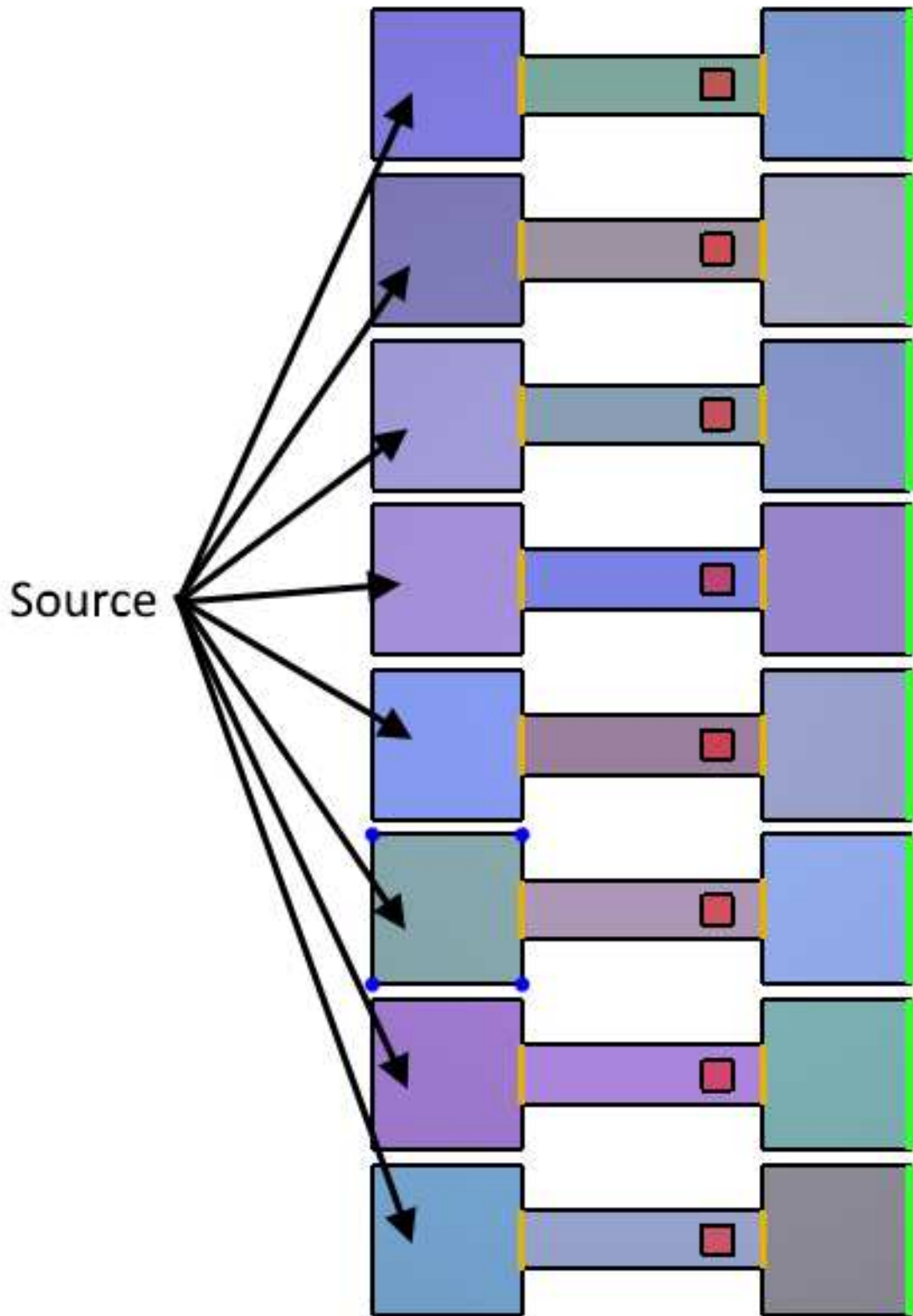

Figure 35. Pathfinder model for user-defined fundamental diagram. This case is for level movement.

The input to Pathfinder consists of the speed (or speed ratio) for each case and the normalized

speed-density curve, [Figure 36](#).

In addition, it is necessary to set the occupant size to correspond to the person density defined by the standard.

Knowing the density, we can assume tight hexagonal packing as follows:

[stem 278f0af8a2af84cc5bba1615ed85dbb3]

or:

[stem fb733f0d97cfd3f14f3f59e767a98203]

Where:

S is the spacing distance between centers of the hex-packed circles. For a density of **10 pers/m²** the spacing is **34 cm**.

In addition, it is necessary to set the corresponding comfort distance to zero.

Output Data for Input to Pathfinder										
This data is formatted so that you can copy it and paste into the Pathfinder Speed-Density table.										
Density units are persons/m2, speed-density curve is normalized, speed fraction is specified for stairs and ramps.										
Max Speeds (m/s)		Speed Fraction		Hex Pack Distance						
Room =	1.667	Room =	N/A	Distance =	0.340 m (Shoulder Width in Pathfinder, set Comfort Distance = 0)					
Stair Down =	1.667	Stair Down =	1.000							
Stair Up =	1.000	Stair Up =	0.600							
Ramp Down =	1.917	Ramp Down =	1.150							
Ramp Up =	1.333	Ramp Up =	0.800							
Room		Stair Down		Stair Up		Ramp Down		Ramp Up		
Density (p/m2)	Fraction of Max	Density (p/m2)	Fraction of Max	Density (p/m2)	Fraction of Max	Density (p/m2)	Fraction of Max	Density (p/m2)	Fraction of Max	
0.000	1.000	0.000	1.000	0.000	1.000	0.000	1.000	0.000	1.000	
0.500	1.000	0.500	1.000	0.500	1.000	0.500	1.000	0.500	1.000	
1.000	0.805	1.000	0.953	1.000	0.878	1.000	1.000	1.000	1.000	
1.500	0.687	1.500	0.791	1.500	0.754	1.500	1.000	1.500	0.865	
2.000	0.604	2.000	0.676	2.000	0.666	2.000	0.937	2.000	0.750	
2.500	0.539	2.500	0.587	2.500	0.598	2.500	0.848	2.500	0.661	
3.000	0.486	3.000	0.514	3.000	0.543	3.000	0.776	3.000	0.589	
3.500	0.441	3.500	0.452	3.500	0.496	3.500	0.714	3.500	0.527	
4.000	0.403	4.000	0.399	4.000	0.455	4.000	0.661	4.000	0.474	
4.500	0.369	4.500	0.352	4.500	0.419	4.500	0.614	4.500	0.427	
5.000	0.338	5.000	0.310	5.000	0.387	5.000	0.572	5.000	0.385	
5.500	0.310	5.500	0.271	5.500	0.358	5.500	0.534	5.500	0.347	
6.000	0.285	6.000	0.237	6.000	0.331	6.000	0.499	6.000	0.312	
6.500	0.262	6.500	0.205	6.500	0.307	6.500	0.467	6.500	0.280	
7.000	0.240	7.000	0.175	7.000	0.284	7.000	0.438	7.000	0.251	
7.500	0.220	7.500	0.147	7.500	0.263	7.500	0.410	7.500	0.223	
8.000	0.202	8.000	0.122	8.000	0.244	8.000	0.384	8.000	0.197	
8.500	0.184	8.500	0.097	8.500	0.225	8.500	0.360	8.500	0.173	
9.000	0.168	9.000	0.074	9.000	0.208	9.000	0.337	9.000	0.150	
9.500	0.152	9.500	0.053	9.500	0.191	9.500	0.316	9.500	0.129	
10.000	0.137	10.000	0.032	10.000	0.176	10.000	0.295	10.000	0.108	

Figure 36. Fundamental curves used in this verification problem. The data corresponds to the Russian healthy population (M1).

2.4.3. Results

Speed-density results are presented for each of the five path types (level, stairs up, stairs down, ramp up, ramp down). In these curves, the data is presented over time intervals when "steady-state" conditions have been reached. The gray points represent all the calculated speed-density pairs for all corridors, while the black points are the averaged values for each corridor.

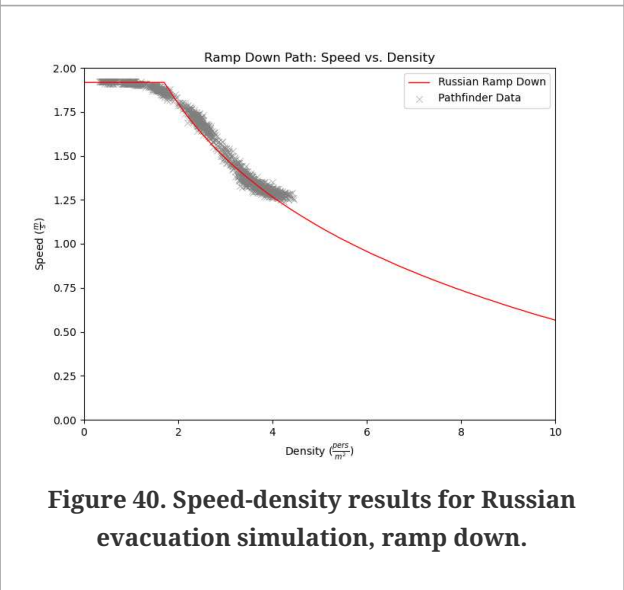
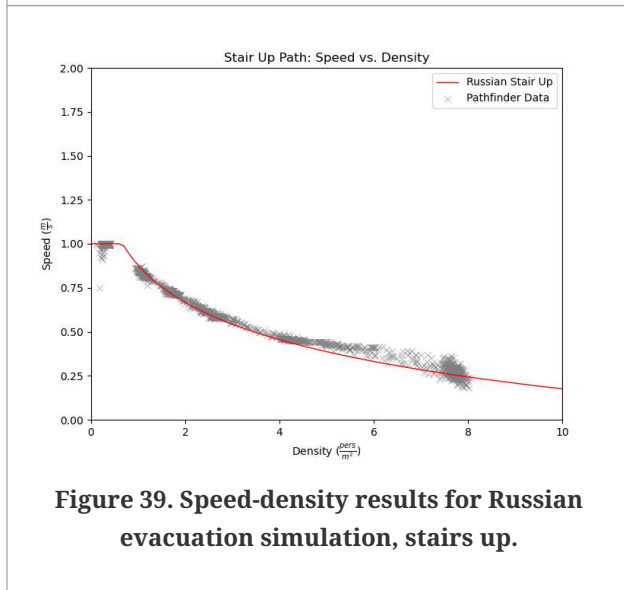
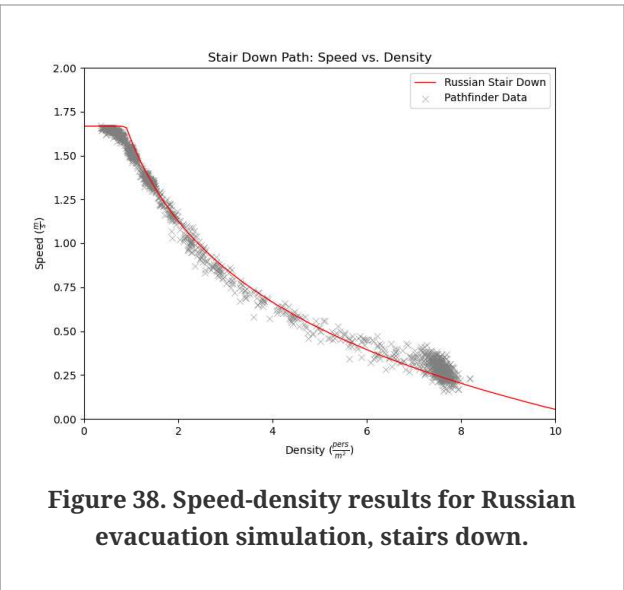
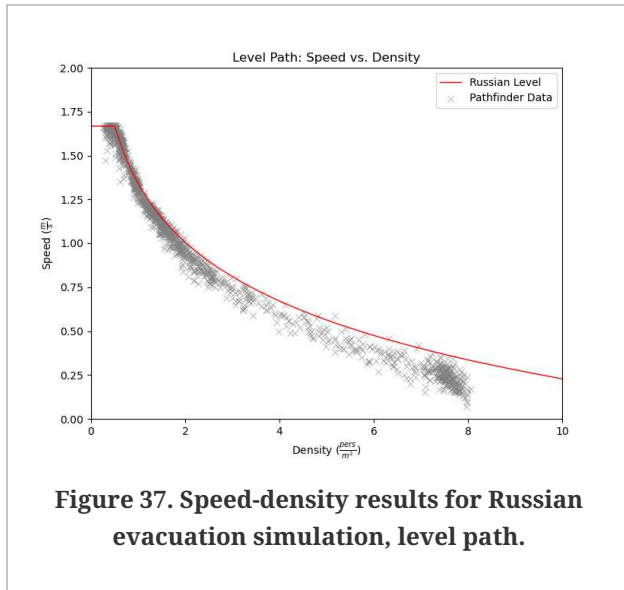

NOTE For this case, the speed of occupants down the ramp is so large that it is not possible to feed occupants from the level supply room at a rate that gives a ramp density exceeding 4 pers/m².

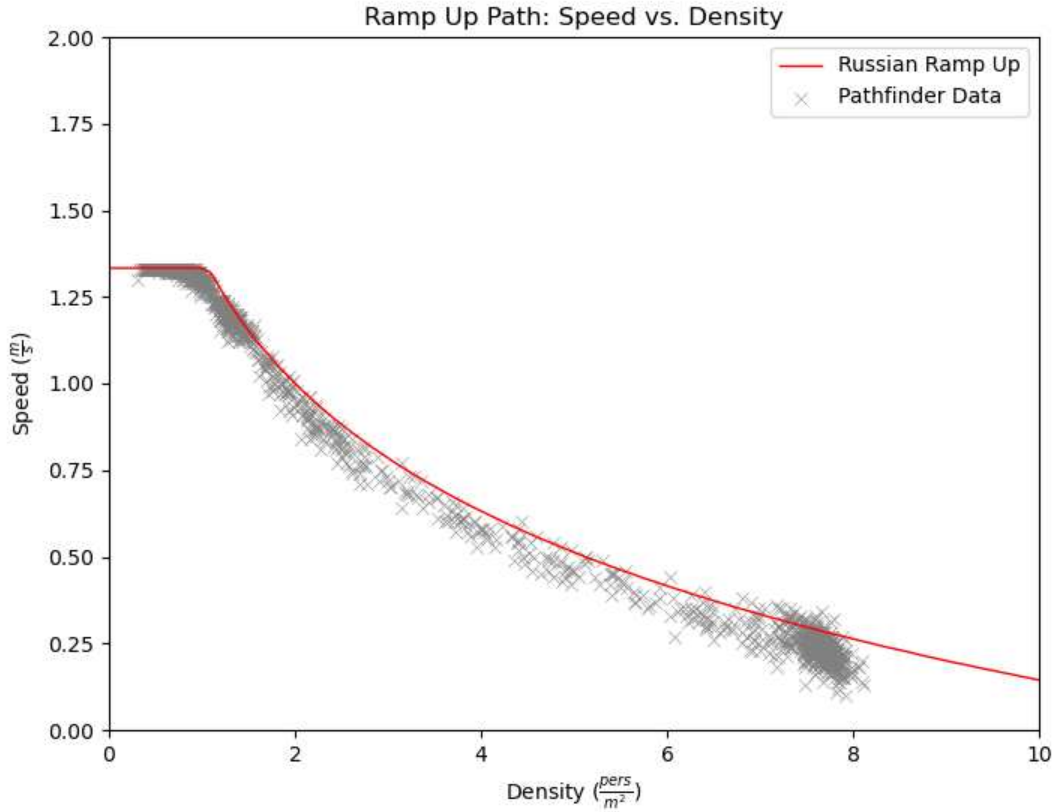

Figure 41. Speed-density results for Russian evacuation simulation, ramp up.

2.4.4. Analysis

These results show that Pathfinder correctly uses the specified speed-density curves for the five different five path types (level, stairs up, stairs down, ramp up, ramp down). For the ramp down case which has specific flows much higher than possible on level space, the Pathfinder movement algorithm limited the maximum density to about 4 pers/m².

NOTE | 4 pers/m² is higher than ever allowed in SFPE calculations.

Chapter 3. Flow Rate Tests

3.1. Door Flow Rates

3.1.1. Background

This test verifies the Pathfinder door flow rate calculation. In steering mode, the door flow rates are not specified, but are emergent behavior based on the occupant movement. SFPE calculates the door flow rates based on the maximum specific flow of 1.316 pers/s-m . For doors, the specified boundary layer is 0.15 m , so a 1 m wide door is calculated to flow at 0.92 pers/s .

3.1.2. Setup Notes

The corresponding Pathfinder model is shown in [Figure 42](#). The door widths range from 0.7 m to 3.0 m , with the entry corridor width 5 m . Two Steering Mode cases were run, one with a constant velocity of 1.19 m/s and one with a uniform velocity distribution of $1.19 \pm 0.25 \text{ m/s}$. In addition, SFPE mode and Steering+SFPE mode cases were run for a uniform velocity distribution of $1.19 \pm 0.25 \text{ m/s}$.

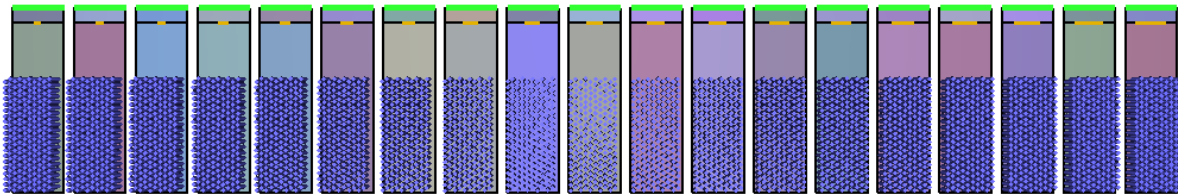

Figure 42. Pathfinder model used to study door flow rates.

3.1.3. Results

The door flow rates are shown in [Figure 43](#) through [Figure 46](#). This data has been averaged over the time periods where the different doors have attained "steady state" flow. For comparison, the red lines show the SFPE flow rate for the door width and a 0.15 m boundary.

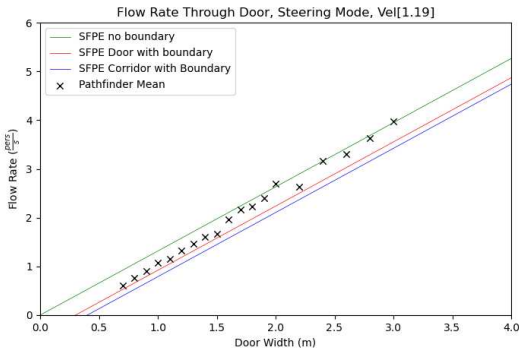

Figure 43. Door flow rates for Steering mode and occupants with a max speed of 1.19 m/s.

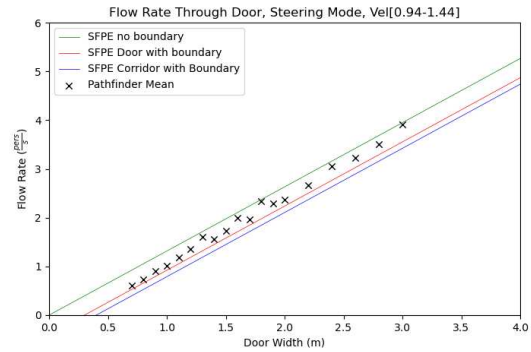

Figure 44. Door flow rates for Steering mode and occupants with a max speed distribution of 1.19 ± 0.25 m/s.

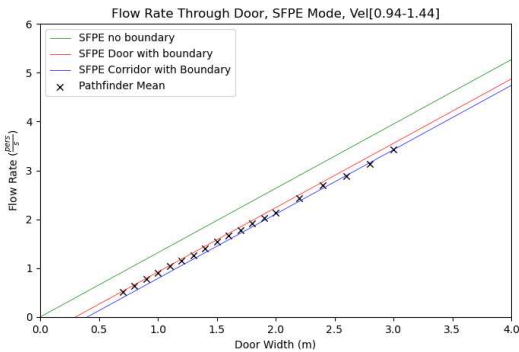

Figure 45. Door flow rates for SFPE mode and occupants with a max speed distribution of 1.19 ± 0.25 m/s.

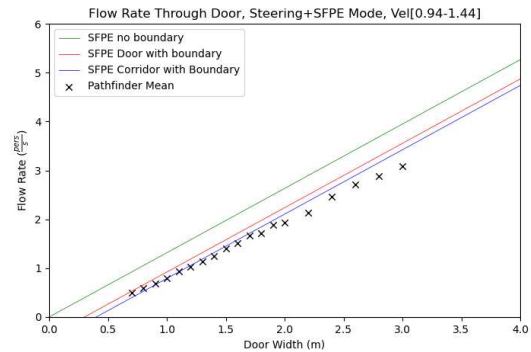

Figure 46. Door flow rates for Steering+SFPE mode and occupants with a max speed distribution of 1.19 ± 0.25 m/s.

3.1.4. Analysis

The Pathfinder Steering mode calculations give slightly higher door flow rates than predicted using the SFPE calculations. The Pathfinder SFPE mode results are essentially identical to the SFPE predictions. The Steering+SFPE mode results are somewhat lower than the SFPE predictions.

The predictions are satisfactory.

3.2. Stair Flow Rates

3.2.1. Background

This test verifies the Pathfinder stair flow rate calculation. In steering mode, the stair flow rates are not specified, but are emergent behavior based on the occupant movement, including

maximum speed as a function of stair riser/tread dimensions and occupant density. SFPE calculates the stair flow rates based on the maximum specific flow that is a function of riser/tread dimensions, see Figure 47. For stairs, the specified boundary layer is 0.15 m, so a 1 m wide stair with rise/run of 178/279 is calculated to flow at 0.71 pers/s.

Egress Component		F_s pers/sec-m of Effective Width (pers/min-ft of Effective Width)
Corridor, aisle, ramp, doorway		1.32 (24.0)
Stair Riser, mm (in.)	Stair Tread, mm (in.)	
190 (7.5)	254 (10)	0.94 (17.1)
178 (7.0)	279 (11)	1.01 (18.5)
165 (6.5)	305 (12)	1.09 (20.0)
165 (6.5)	330 (13)	1.16 (21.2)

Figure 47. Specific flow for stairs as a function of riser and tread dimensions. Ref. Table 8 in SFPE Engineering Guide to Human Behavior in Fire.

3.2.2. Setup Notes

The corresponding Pathfinder model is shown in Figure 48. The door widths range from 0.7 m to 3.0 m. Entry corridor width is 5 m. Stairs have a total rise of 7 m and a run of 11 m.

Two Steering Mode cases were run, one with a constant velocity of 1.19 m/s and one with a uniform velocity distribution of 1.19 ± 0.25 m/s. In addition, SFPE mode and Steering+SFPE mode cases were run for a uniform velocity distribution of 1.19 ± 0.25 m/s

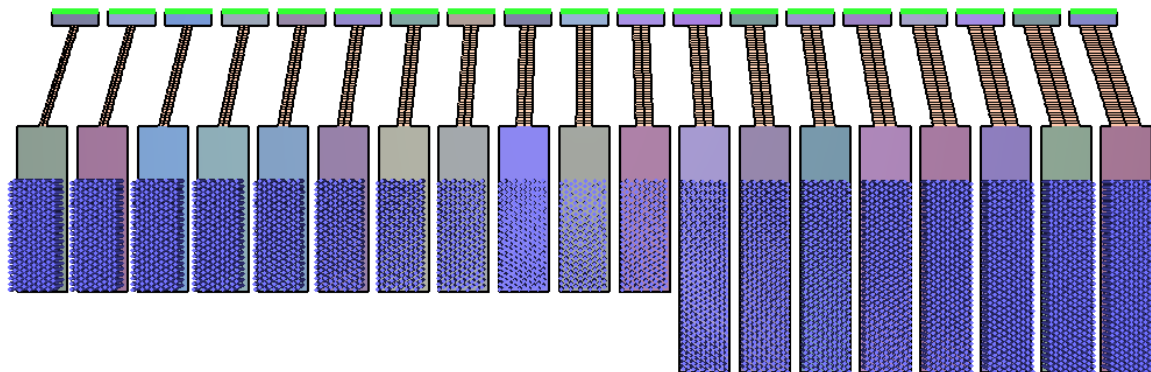
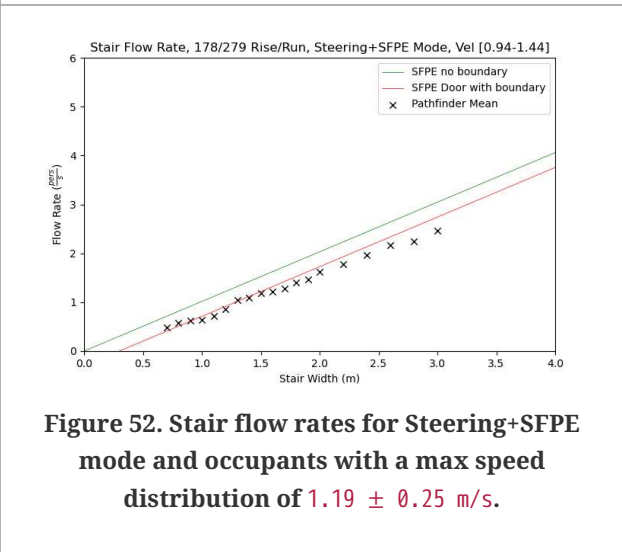
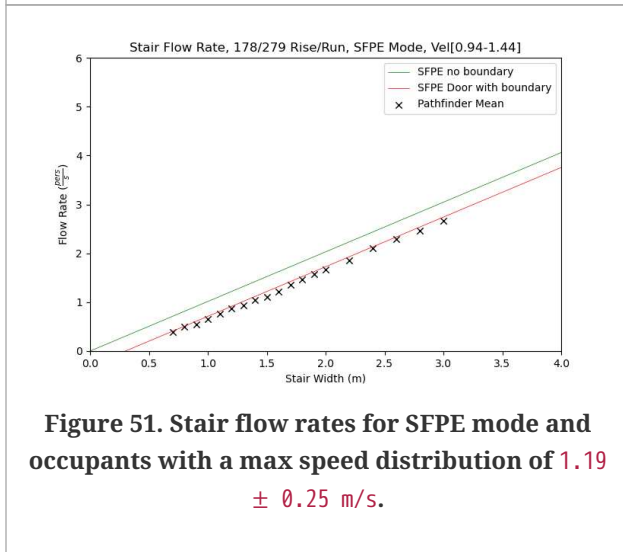
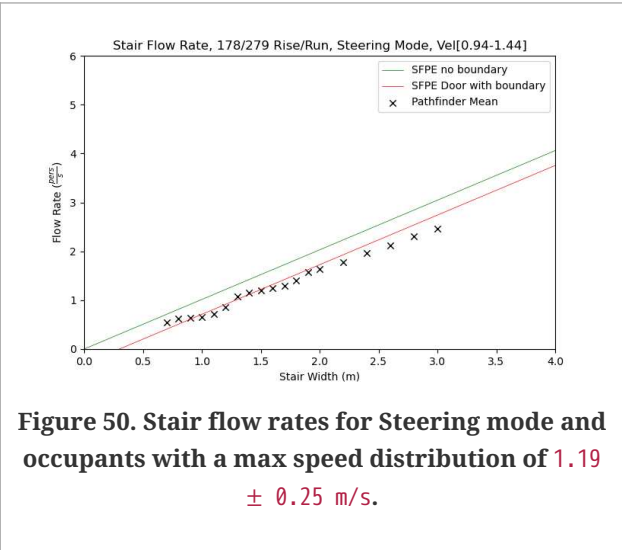
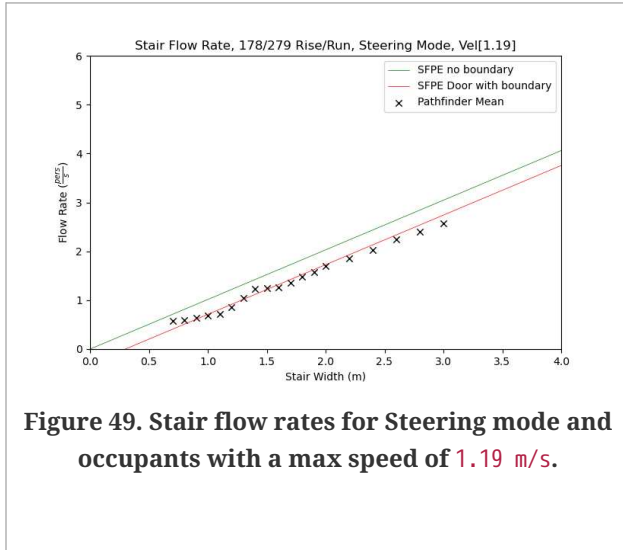

Figure 48. Pathfinder model used to study stair flow rates.

3.2.3. Results

The stair flow rates are shown in Figure 49 through Figure 52. This data has been averaged over the time periods where the different stairs have attained "steady state" flow. For comparison, the red lines show the SFPE flow rate for the stair width and a 0.15 m boundary.



3.2.4. Analysis

The Pathfinder Steering mode calculations lie close to the SFPE calculations. The Pathfinder SFPE mode results are essentially identical to the SFPE predictions. The Steering+SFPE mode results are somewhat lower than the SFPE predictions.

The predictions are satisfactory.

3.3. Corridor Flow Rates

3.3.1. Background

This test is similar to the door flow rate verification but examines flow rates through corridors for which SFPE specifies a 0.2 m boundary layer (a 1 m corridor has a 0.79 pers/s flow rate). It also tests the sensitivity of Pathfinder to the width of the entry shoulder on each side of the corridor.

3.3.2. Setup Notes

The Pathfinder models are shown in [Figure 53](#) and [Figure 54](#). The corridor widths are 1 m and 3 m and the shoulder widths range from 0 to 2 m . Steering Mode cases were run, one with a constant velocity of 1.19 m/s and one with a uniform velocity distribution of $1.19 \pm 0.25\text{ m/s}$. In addition, SFPE mode and Steering+SFPE mode cases were run for a uniform velocity distribution of $1.19 \pm 0.25\text{ m/s}$.

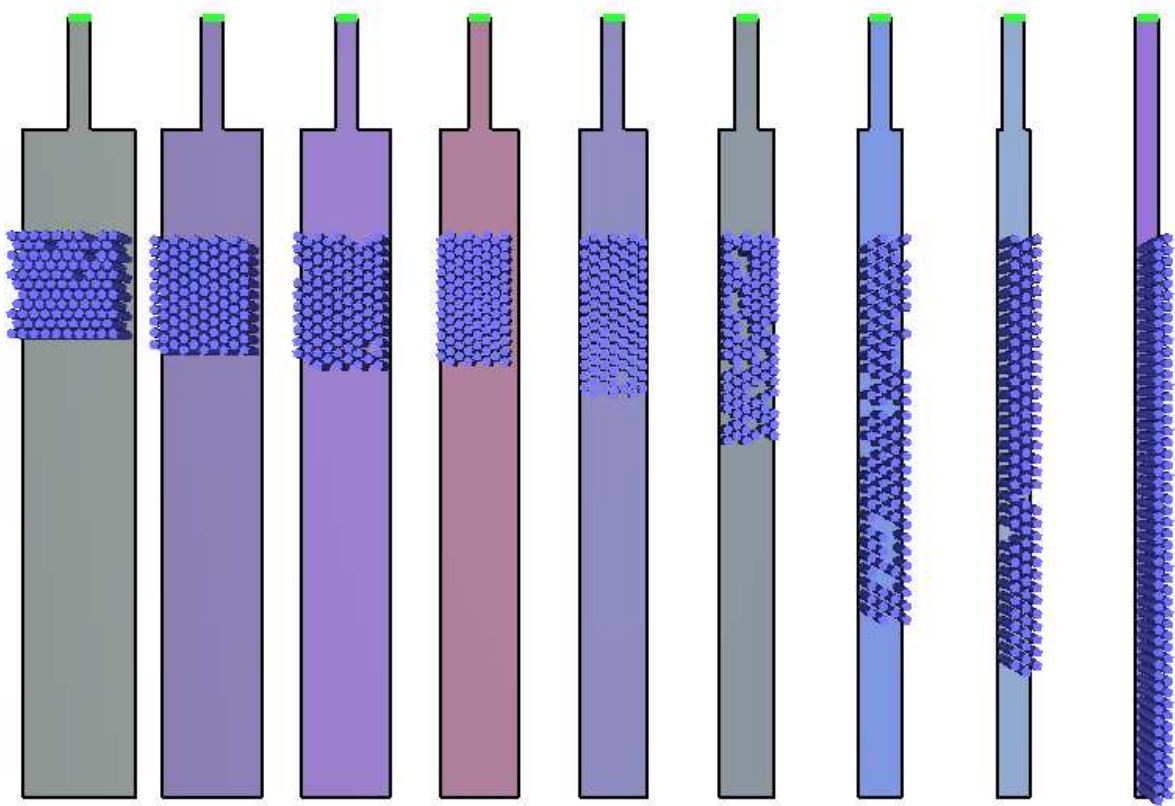

Figure 53. Pathfinder model used to study 1 m wide corridor flow rates.

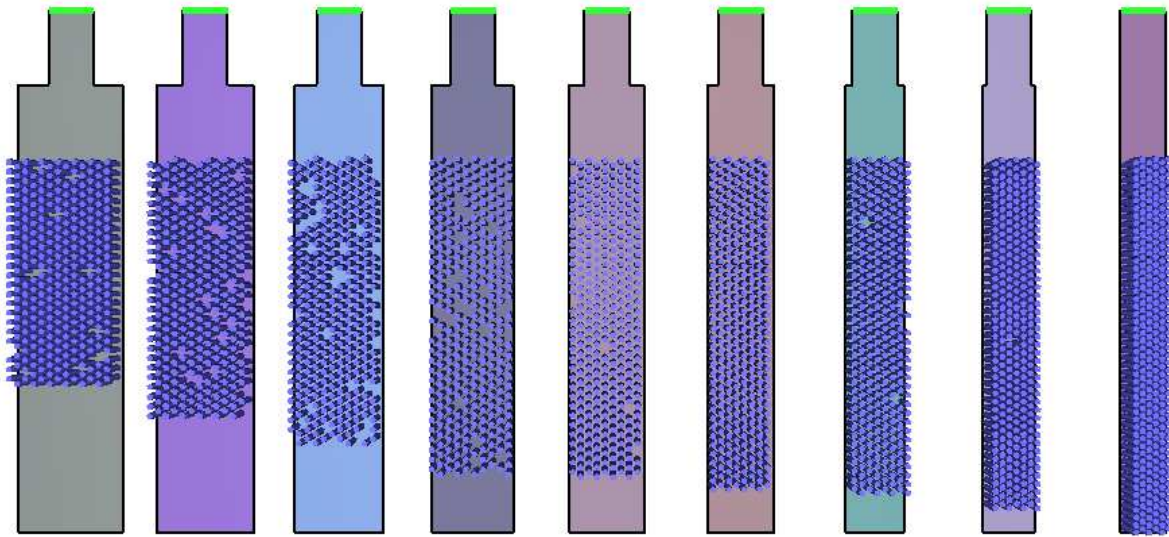
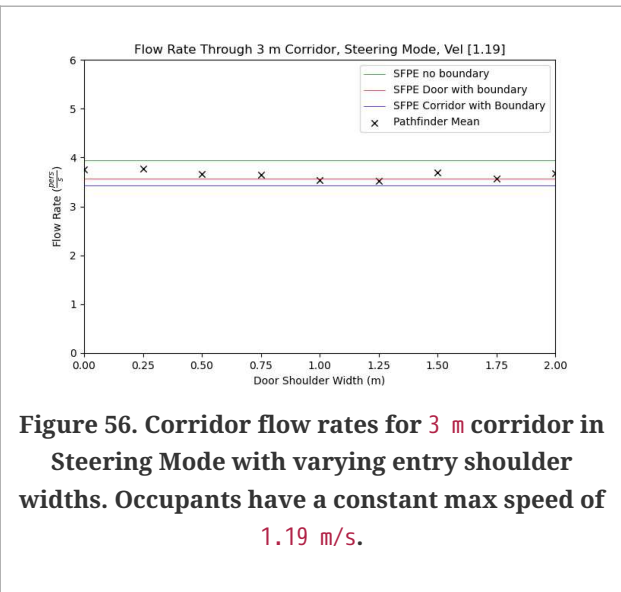
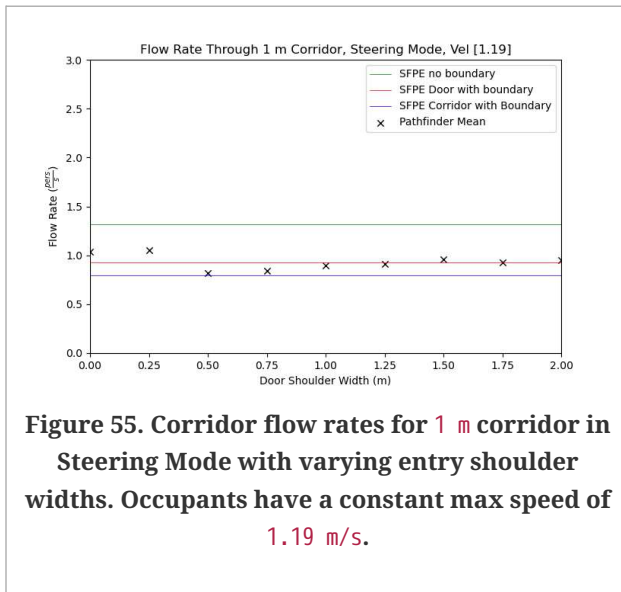

Figure 54. Pathfinder model used to study 3 m wide corridor flow rates.

3.3.3. Results

The corridor flow rates are shown in Figure 55 through Figure 62. This data has been averaged over the time periods where the different doors have attained "steady state" flow. For comparison, the blue lines show the SFPE corridor flow rate.



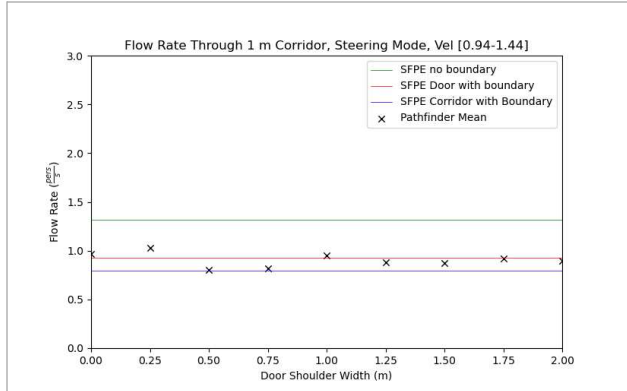

Figure 57. Corridor flow rates for 1 m corridor in Steering Mode with varying entry shoulder widths. Occupants have a max speed distribution of 1.19 ± 0.25 m/s.

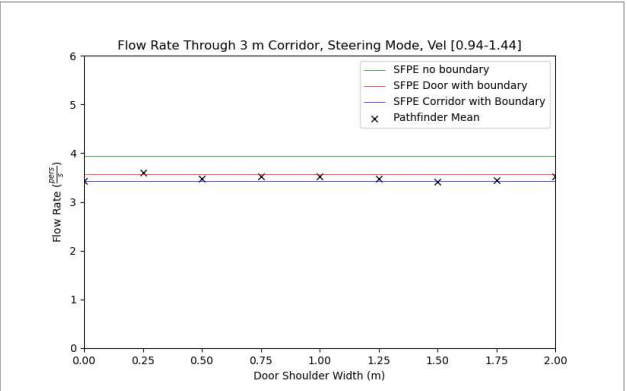

Figure 58. Corridor flow rates for 3 m corridor in Steering Mode with varying entry shoulder widths. Occupants have a max speed distribution of 1.19 ± 0.25 m/s.

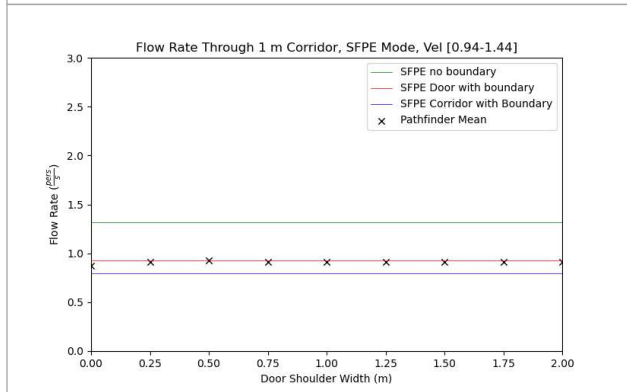

Figure 59. Corridor flow rates for 1 m corridor in SFPE Mode with varying entry shoulder widths. Occupants have a max speed distribution of 1.19 ± 0.25 m/s.

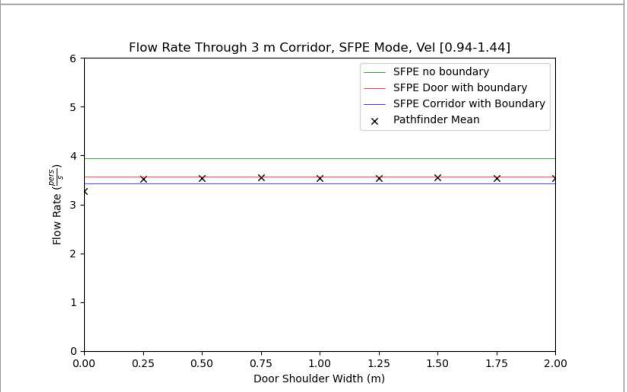
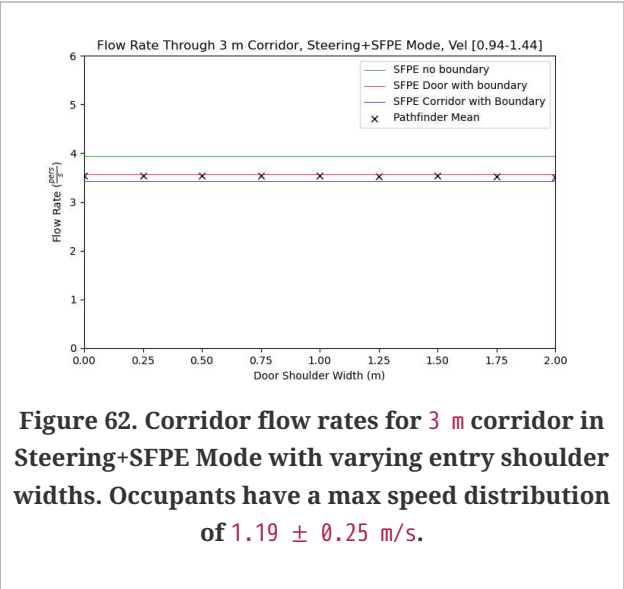
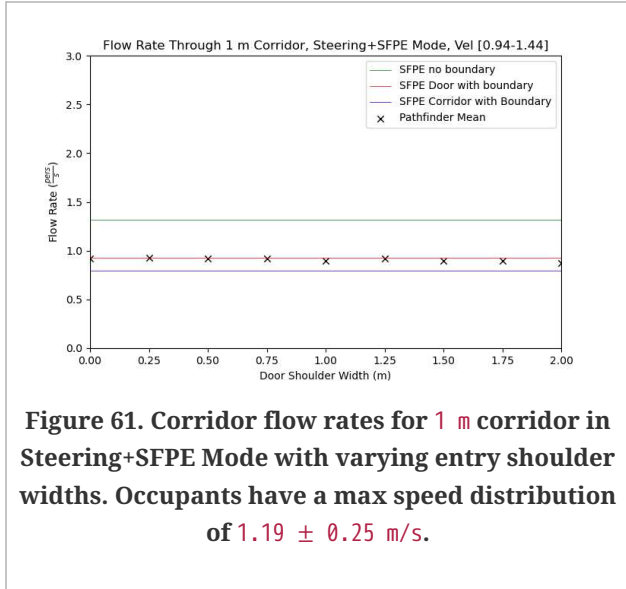

Figure 60. Corridor flow rates for 3 m corridor in SFPE Mode with varying entry shoulder widths. Occupants have a max speed distribution of 1.19 ± 0.25 m/s.



3.3.4. Analysis

For the 1 m wide corridor, the Pathfinder calculations give slightly higher flow rates than predicted using the SFPE calculations. For the 3 m door, the flow rates are nearly identical to the SFPE calculations. The results are not sensitive to the width of the entry shoulder.

For SFPE mode, the corridor width does not affect the calculation, so the flow rates are controlled primarily by the exit door flow rate. Also for SFPE mode, when the corridor is the same width as the entry room, the density in the corridor/entry room slows the walking speed so the zero shoulder width corridor cases show slightly lower flow rates.

The correlation between the Pathfinder calculations and the expected flow rates is satisfactory.

Chapter 4. Behavior Tests

4.1. Refuge Room as Final Destination

4.1.1. Background

This tests simple behaviors, including exits and a refuge room. 150 occupants were evenly divided with three different behaviors: go to one of two exits or go to the refuge room (a final destination).

4.1.2. Setup Notes

The occupants were initially located in one room and then proceed to their exits as shown in [Figure 63](#).

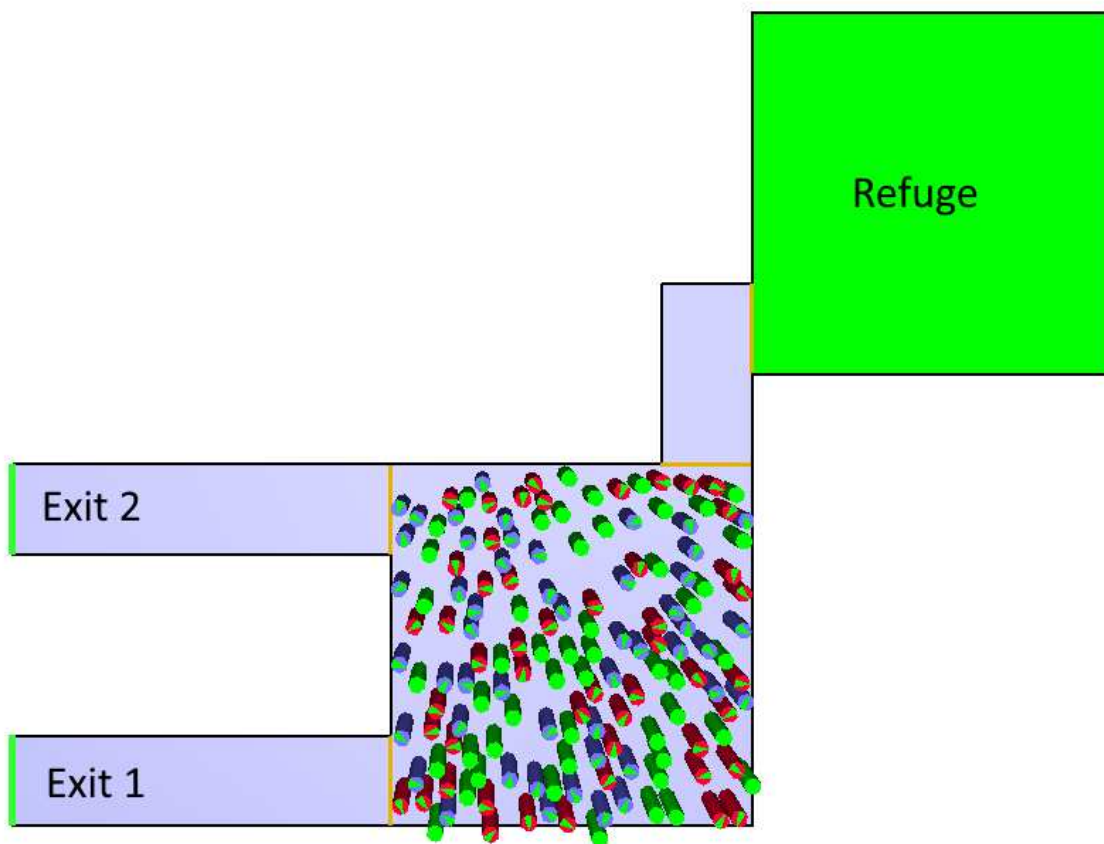

Figure 63. Model used to test behaviors.

4.1.3. Results

[Figure 64](#) shows a plot of the refuge room usage. The 50 occupants assigned to use the refuge did so. The same results were obtained for SFPE and Steering+SFPE modes.

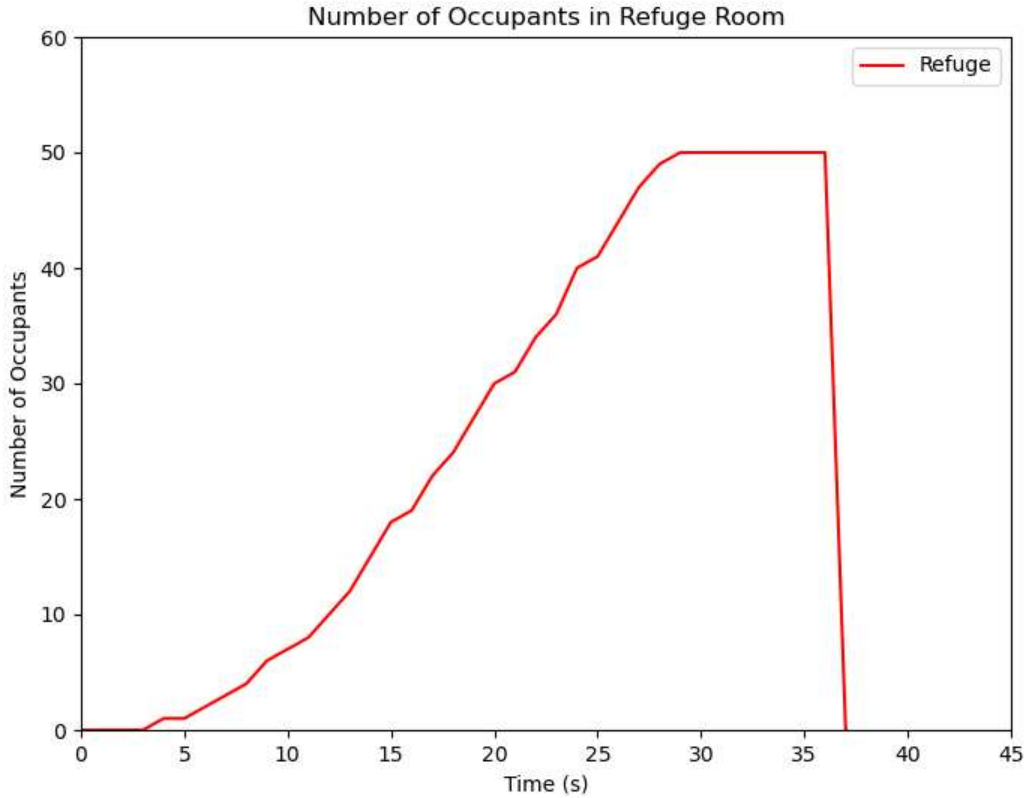

Figure 64. Occupants in the refuge room. Steering mode simulation.

4.1.4. Analysis

The occupants proceeded to use the exits and refuge associated with their behaviors.

The Pathfinder calculations performed as expected.

4.2. Grouping Behavior

4.2.1. Background

This case tests the effect of grouping on door flow rates. We use the same model as used for the door flow rate tests, but the occupants are grouped into groups of 3 and 5 people.

4.2.2. Setup Notes

The model is shown in [Figure 65](#). It is the same as the previous door flow rate model (steering mode with a uniform velocity distribution of 1.19 ± 0.25 m/s), except the space downstream of the doors is extended to allow group leaders to pause and wait for the rest of their group to catch

up.

Dynamic grouping was used with the Number of Members in the group defined as 3 and 5 and the group minimum size of 1. Two group formations were used: a tight group formation with a Maximum Distance of 1.0 m and a Slowdown Time of 3 s, and the default group with properties with a Maximum Distance of 2.0 m and a Slowdown Time of 3 s. The maximum speed was defined as a uniform distribution of 1.19 ± 0.25 m/s. As a result, members of a group will have different speeds, so the faster members slow down to keep the group together.

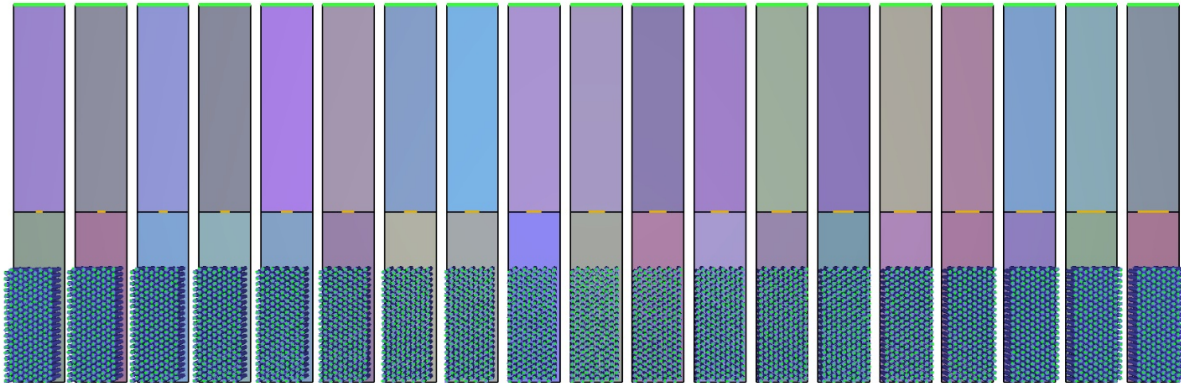

Figure 65. Model used for door flow rate calculations with groups.

4.2.3. Results

Figure 66 through Figure 70 show plots of door flow rates in steering mode. Without grouping (Figure 66) the door flow rate for the 3 m door is slightly less than the previous model. This is due to the downstream effect of movement in the corridor that slightly slows movement through the door.

When grouped, the steering mode door flow rates do not change significantly for the default grouping parameters, but do decrease for the tight grouping parameters. This is because the tight grouping means increased delays as the group waits to reform.

Grouping in SFPE mode does not change the door flow rates, Figure 71.

Figure 72 shows the results for Steering+SFPE mode for the tight grouping with a group size of 5. These results show that the door flow rate constraint slows the door flow rate further.

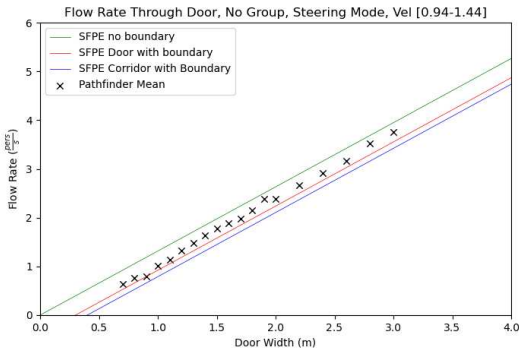

Figure 66. Door flow rates without grouping.

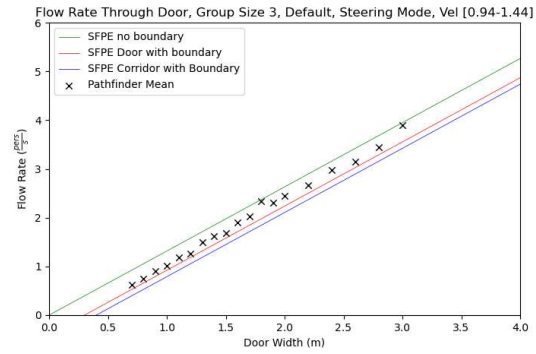

Figure 67. Door flow rates for steering mode with default parameters and group of size 3.

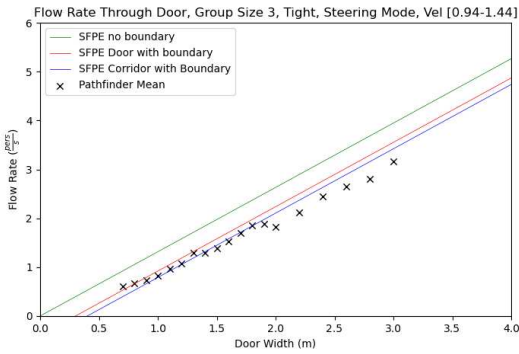

Figure 68. Door flow rates for steering mode with default parameters and tight group of size 3.

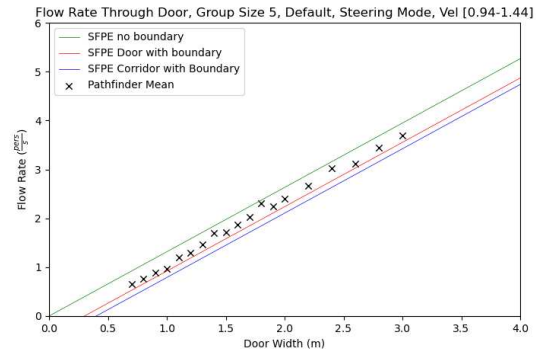

Figure 69. Door flow rates for steering mode with default parameters and group of size 5.

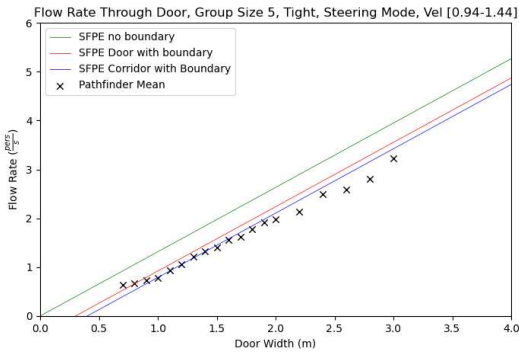

Figure 70. Door flow rates for steering mode with default parameters and tight group of size 5.

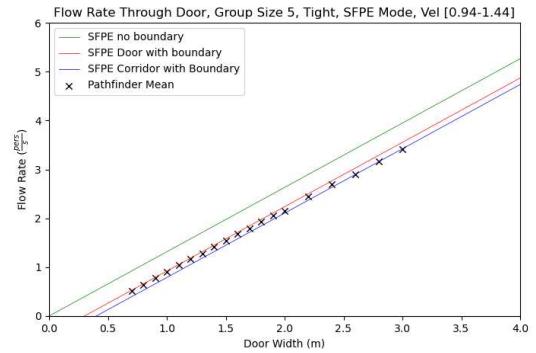

Figure 71. Door flow rates for SFPE mode with default parameters and tight group of size 5.

4.2.4. Analysis

Tight groups show slower movement through doors. For the default group parameters, which

allows the members of the group to become more separated, the effect on door flow rates is small.

The Pathfinder calculations performed as expected.

4.3. Corridor Merging

4.3.1. Background

This test expands a corridor merging problem discussed by Galea et al. ([Galea, Sharp, and Lawrence 2008](#)). The problem consists of two flow streams meeting at a junction and continuing to the exit. We add a variation in corridor width to the original Galea problem. We also add a T-junction geometry as described by Zhang et al. ([Zhang et al. 2011](#)).

4.3.2. Setup Notes

[Figure 73](#) shows the Galea ("adjacent") geometry and typical merging behavior for a 3 m wide corridor. [Figure 74](#) shows the T-junction ("opposite") geometry model with typical merging behavior. For both geometries we also solve for 1 m wide corridors.

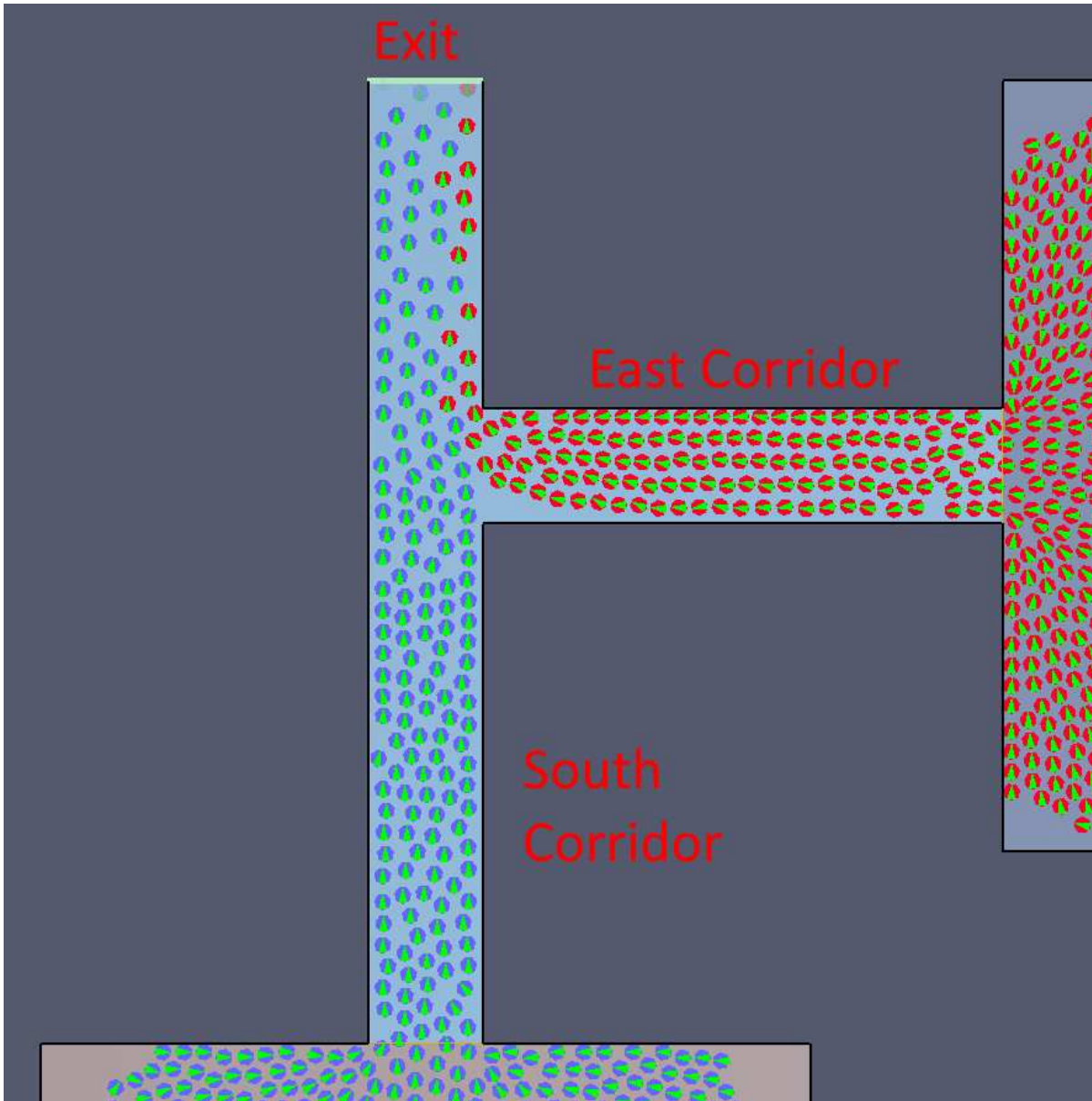

Figure 73. Model for merging at a corridor junction. Called an "adjacent' geometry.

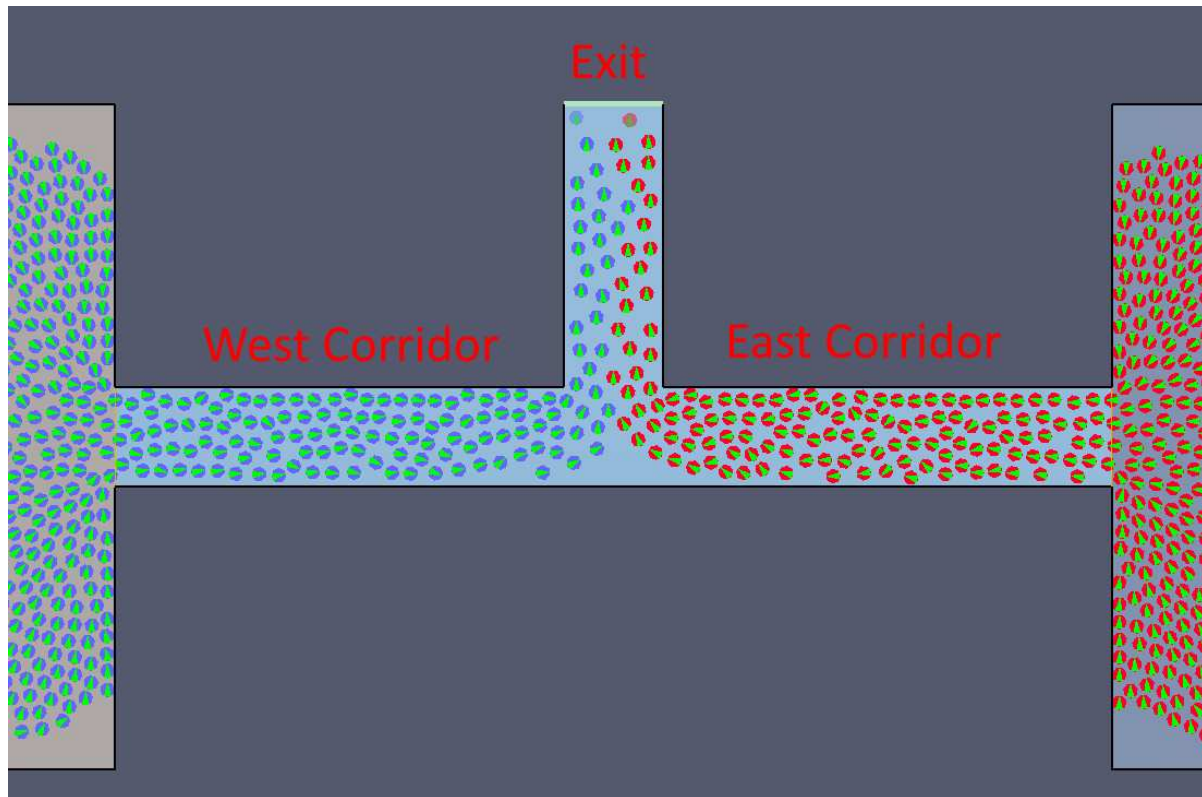

Figure 74. The geometry of a T-junction, called an "opposite" geometry.

4.3.3. Results

The merging ratios and exit flow rates for the adjacent geometry are shown in [Figure 75](#) and [Figure 76](#). These were calculated after the door flow rates had reached "steady state" values. [Figure 77](#) and [Figure 78](#) show the same results for the "opposite" geometry.

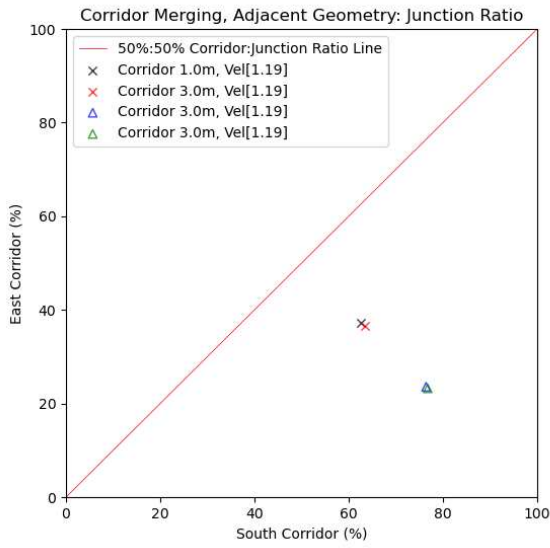

Figure 75. Merging ratios for merging at a corridor junction with "adjacent" configuration.

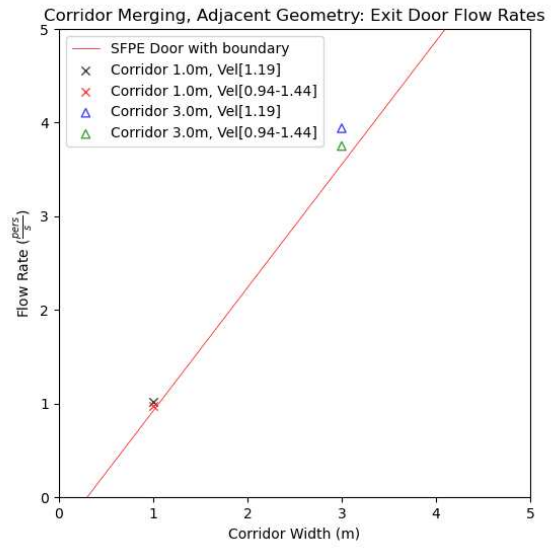

Figure 76. Exit door flow rates for merging at a corridor junction with "adjacent" configuration.

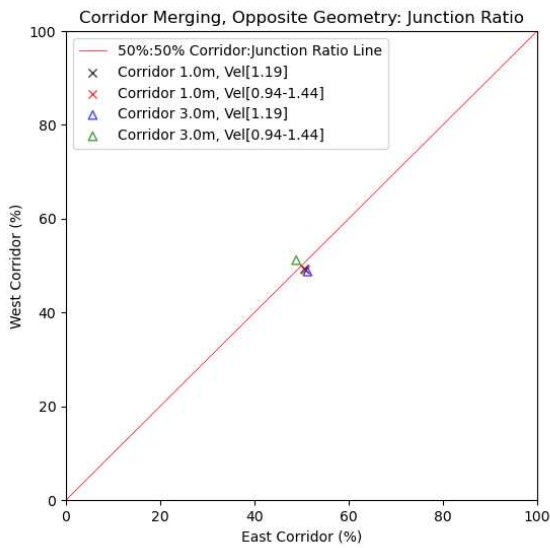

Figure 77. Merging ratios for merging at a corridor junction with "opposite" configuration.

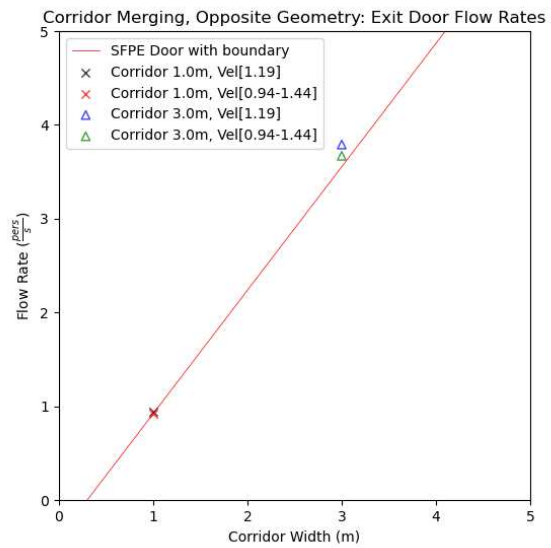

Figure 78. Exit door flow rates for merging at a corridor junction with "opposite" configuration.

4.3.4. Analysis

In all cases for the "opposite" geometry, the merging flows are balanced with 50:50 ratios. This matches the Zhang et al. (Zhang et al. 2011) experimental results.

The "adjacent" geometry case is more interesting. For a 1 m corridor, the merging ratios favor the south (straight) corridor flow (approximately 60:40). However, for the wider 3 m corridor, the south (straight) corridor flow strongly dominates the merging behavior (approximately 75:25). The Galea et al. (Galea, Sharp, and Lawrence 2008) paper examines the effects of different occupant "drives" on merging, but does not examine the effect of different corridor geometry.

The Pathfinder results are satisfactory.

4.4. Stairway Merging

4.4.1. Background

This test expands the stair merging problem discussed by Galea et al. (Galea, Sharp, and Lawrence 2008). The paper categorizes two stair merging geometries: "adjacent" (Figure 79) and "opposite" (Figure 79) defined by how the floor occupants merge at the landing relative to the occupants descending the stairs. We have added a third "open" geometry in which the floor has direct access to the exit stair (Figure 81).

The following images show the categorization of stair merging geometries. The arrows indicate the "up" direction on the stairs, not the flow direction.

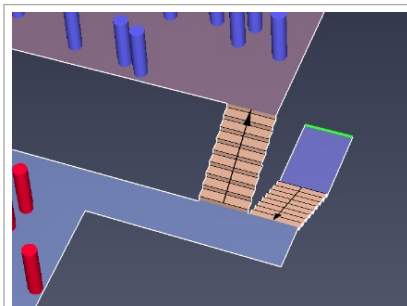

Figure 79. Adjacent

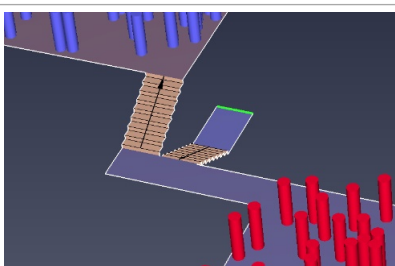

Figure 80. Opposite

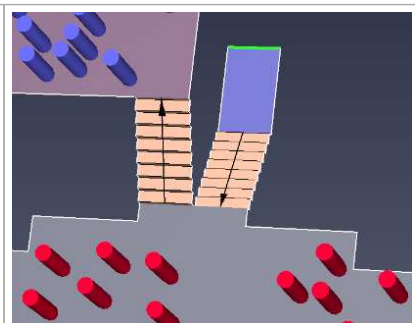

Figure 81. Open

4.4.2. Setup Notes

The width of the stairs was 1.5 m and solutions were made for corridor widths of 1.0 m and 1.45 m (Figure 82). The first floor is at $Z = 1.6$ m and the second at $Z = 3.2$ m. The rise/run of the stairs is approximately 7/11 with a total stair length of 2.97 m. For this stair, the SFPE guidelines give a speed that is 77% of the free walking speed.

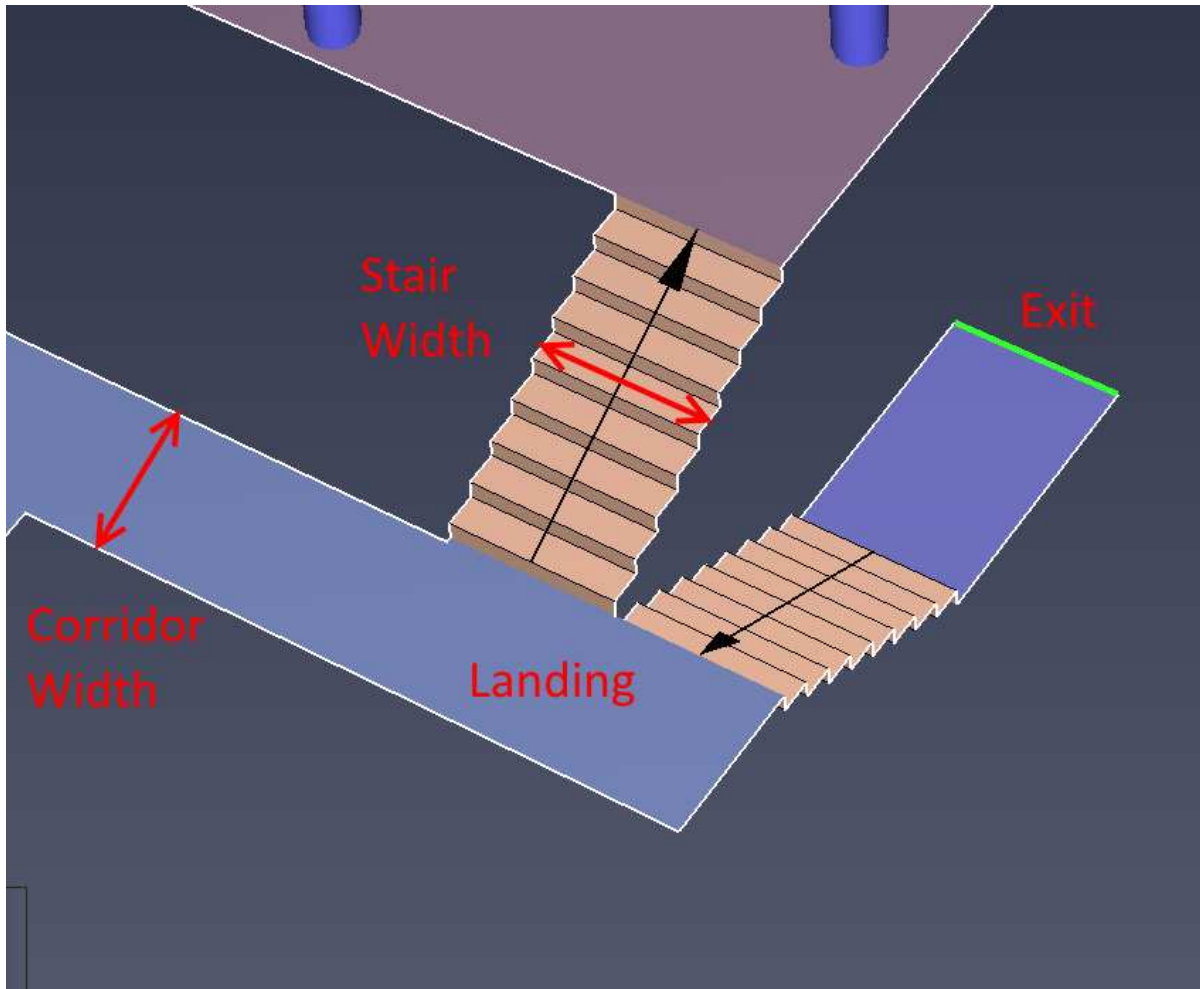
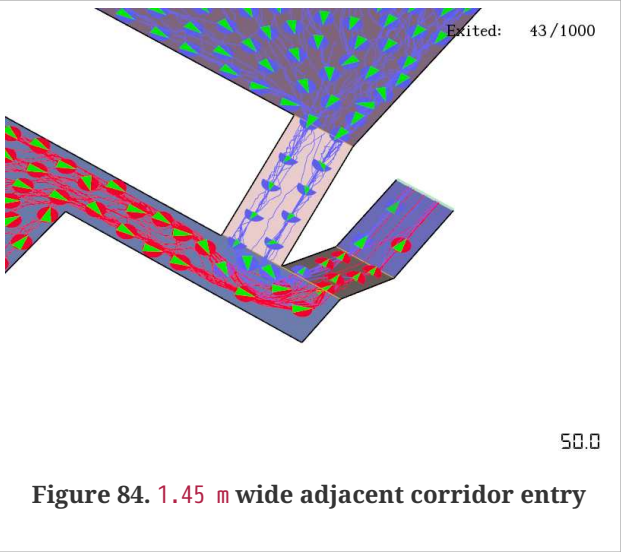
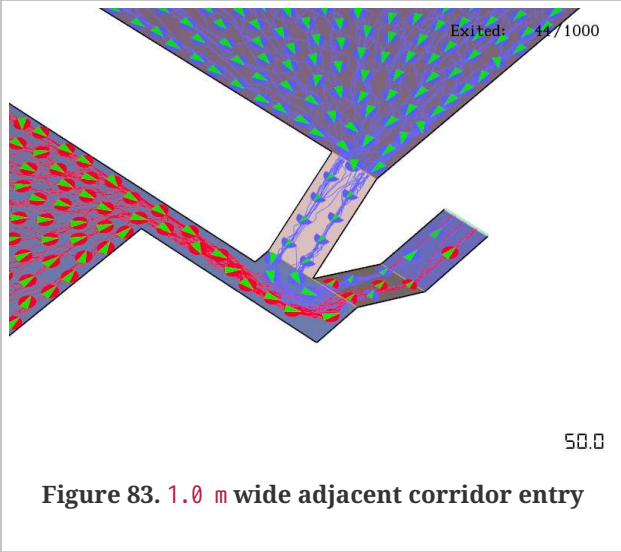

Figure 82. Stair merging geometry. The arrows indicate the "up" direction on the stairs, not the flow direction.

4.4.3. Results

Typical results for the merging behavior for the adjacent geometry with corridor widths of 1.0 m (Figure 83) and 1.45 m (Figure 84) are shown below. For the default occupant dimensions, the 1.0 m narrow corridor requires a "staggered" walking pattern while the wider corridor enables "side by side" walking. As a result, the floor flow is more dominant for the wider entry corridor.

The merging ratios and exit flow rates for all cases are shown in Figure 87, Figure 88, Figure 89, and Figure 90. In the "open" geometry, the floor flow dominates the merging behavior.



Typical merging behavior for the "opposite" configuration with 1.19 m/s occupant speed and different corridor entry widths are shown below.

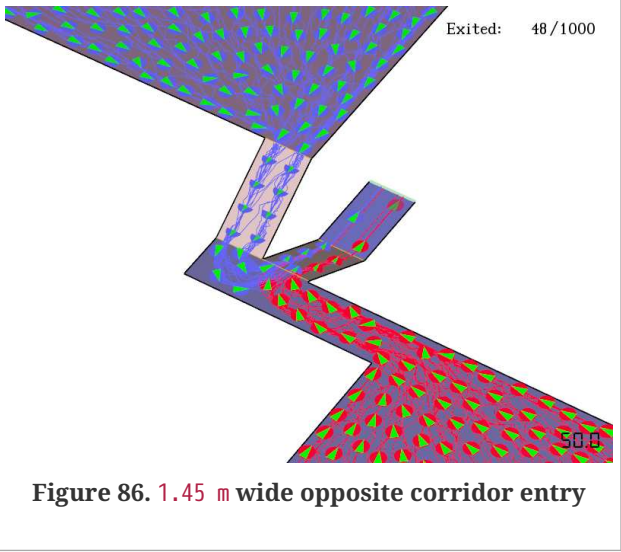
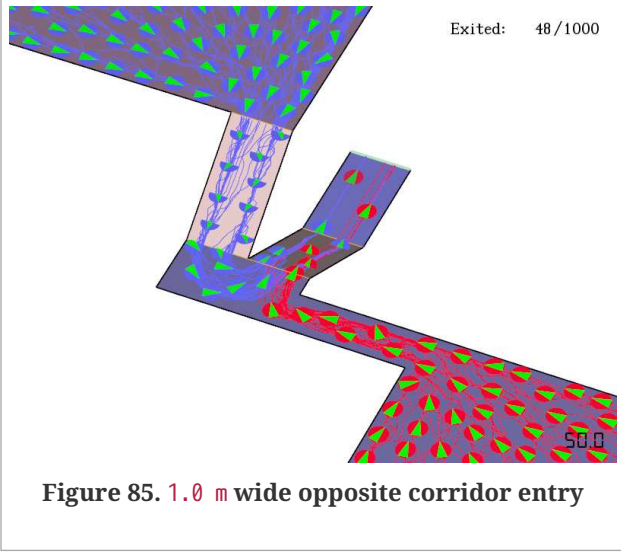

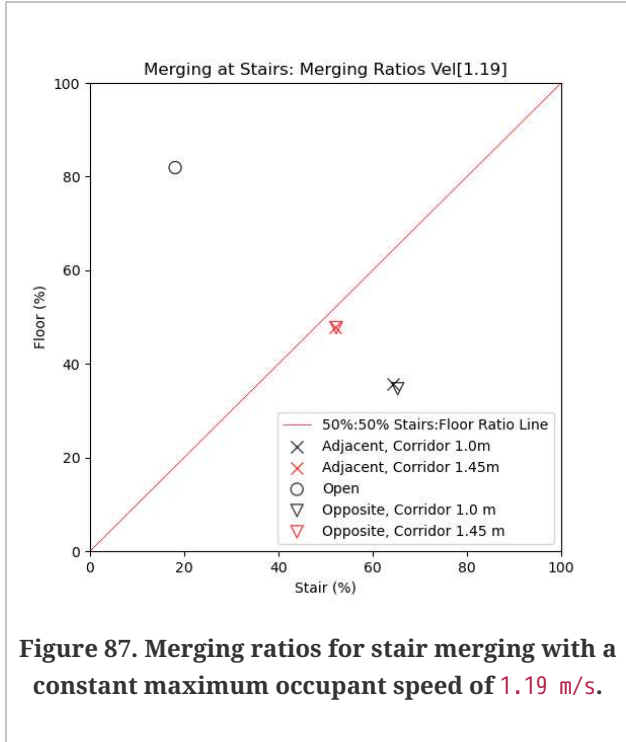

Figure 87. Merging ratios for stair merging with a constant maximum occupant speed of 1.19 m/s.

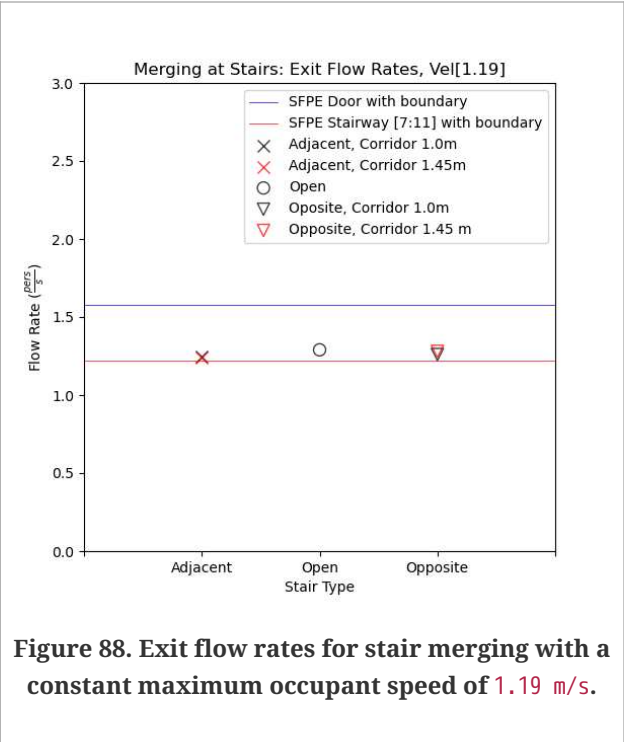

Figure 88. Exit flow rates for stair merging with a constant maximum occupant speed of 1.19 m/s.

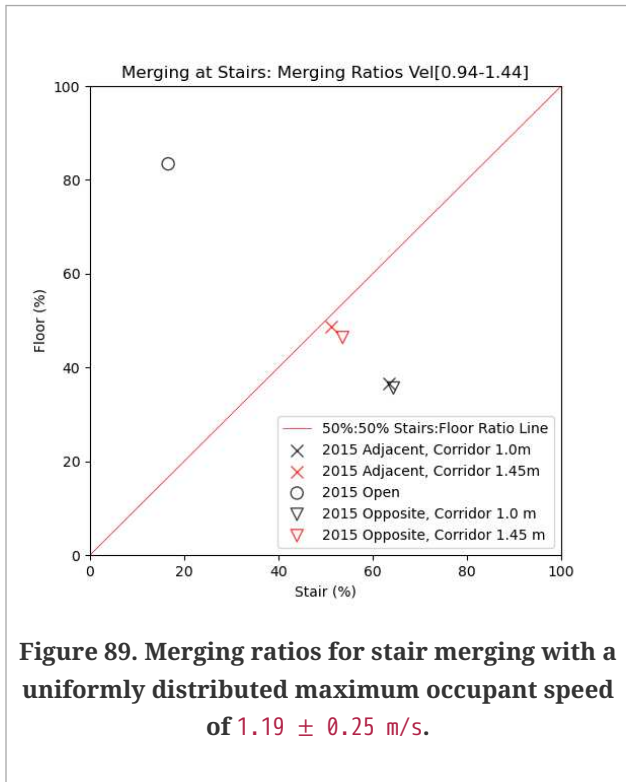

Figure 89. Merging ratios for stair merging with a uniformly distributed maximum occupant speed of 1.19 ± 0.25 m/s.

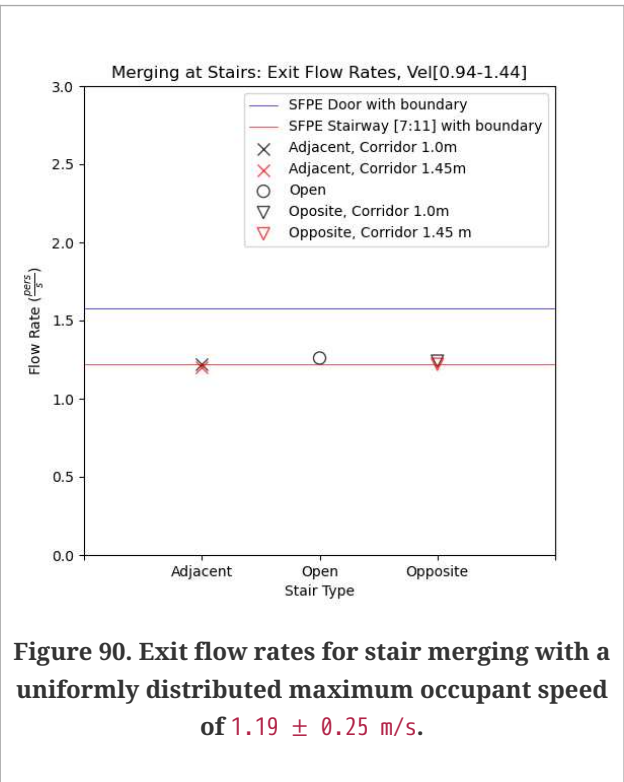

Figure 90. Exit flow rates for stair merging with a uniformly distributed maximum occupant speed of 1.19 ± 0.25 m/s.

4.4.4. Analysis

The calculated merging ratios fall within the range of experimental data summarized by Galea et

al. (Galea, Sharp, and Lawrence 2008). The results match a general trend discussed by Galea et al. for the "opposite" geometry to favor floor merging over the "adjacent" geometry. This would appear to be related to congestion that forms at the landing. For the "adjacent" geometry both streams must merge and then proceed to the landing leading to the exit. For the "opposite" case the two streams approach the exit stair in an approximately symmetric pattern, similar to the T-junction case for corridor merging discussed above.

However, it should be noted that Boyce et al. states, "The results indicate that, despite differences in the geometrical location of the door in relation to the stair and the relative stair/door width, the merging was approximately 50:50 across the duration of the merge period in each of the buildings studied." (Boyce, Purser, and Shields 2012) Their experiments noted how individual behavior could change the merge ratios.

The exit flow rates are controlled by the stair flow rate, not the exit door capacity.

The Pathfinder results are satisfactory.

4.5. Passing Slow Occupants on Stairs

4.5.1. Background

This test evaluates the Pathfinder capability to simulate passing behavior around slow occupants on stairs. For this behavior, it is expected that when the stair width is sufficient, faster occupants will pass slower occupants on stairs.

However, the actual effect of disabled or wounded occupants on stairs can be complex. Averill et al. in their report on occupant behavior and egress in the World Trade Center disaster (Averill et al. 2005) noted the following different situations:

- "51 percent of the occupants in WTC 1 and 33 percent in WTC 2 in 2001, noted that injured and disabled persons in the stairwell were a constraint to evacuation. However, occupants were quick to aid these individuals by guiding them throughout their evacuation or simply moving to the side of the stairwell to let those who were injured and other in need pass by when they could."
- "In some cases, occupants noted passing slower mobility-impaired individuals in the stairs and even slowing or stopping behind them."
- "Finally, some occupants reported mobility-impaired occupants waiting on the stairs and/or landings for others to help them or to be rescued by the fire department."

In modeling, the user must be aware of these situations and model accordingly.

4.5.2. Setup Notes

The same model used for the [stair width study](#) was used for this study. The door widths range from 0.7 m to 3.0 m, with the entry corridor width 5 m. Stairs have a total rise of 7 m and a run of 11 m.

Two occupant profiles were defined: a default profile with a uniform velocity distribution of 1.19 ± 0.25 m/s, and a slow profile with a constant velocity of 0.5 m/s. The 0.5 m/s velocity as a low end of the walking speeds for impaired individuals described in [Figure 47](#) of the SFPE Handbook (SFPE 2016).

10 percent of the occupants were given the slow profile (red occupants in [Figure 91](#)). Steering mode was used, since this is the mode in which passing behavior is used.

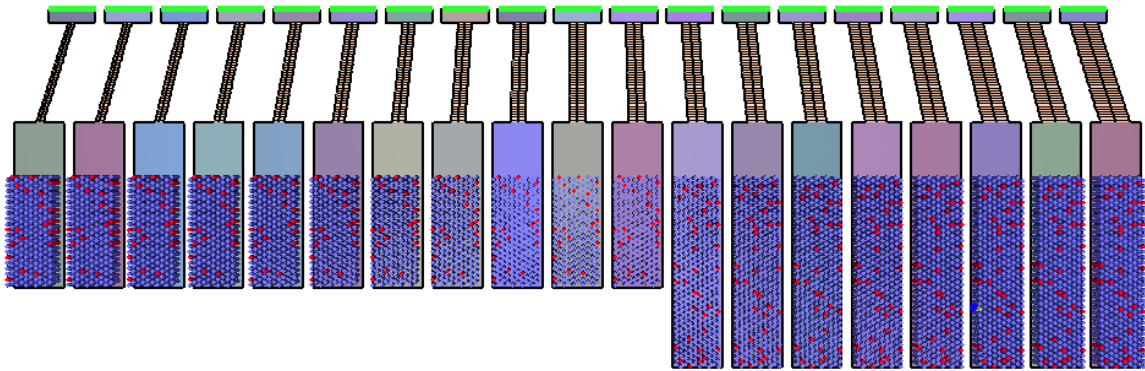

Figure 91. Pathfinder model used to study stair flow rates with mobility-impaired occupants (red).

4.5.3. Results

The stair flow rates with mobility-impaired occupants are shown in [Figure 92](#). This data has been averaged over the time periods where the different stairs have attained "steady state" flow. For comparison, the red lines show the SFPE flow rate for the stair width and a 0.15 m boundary.

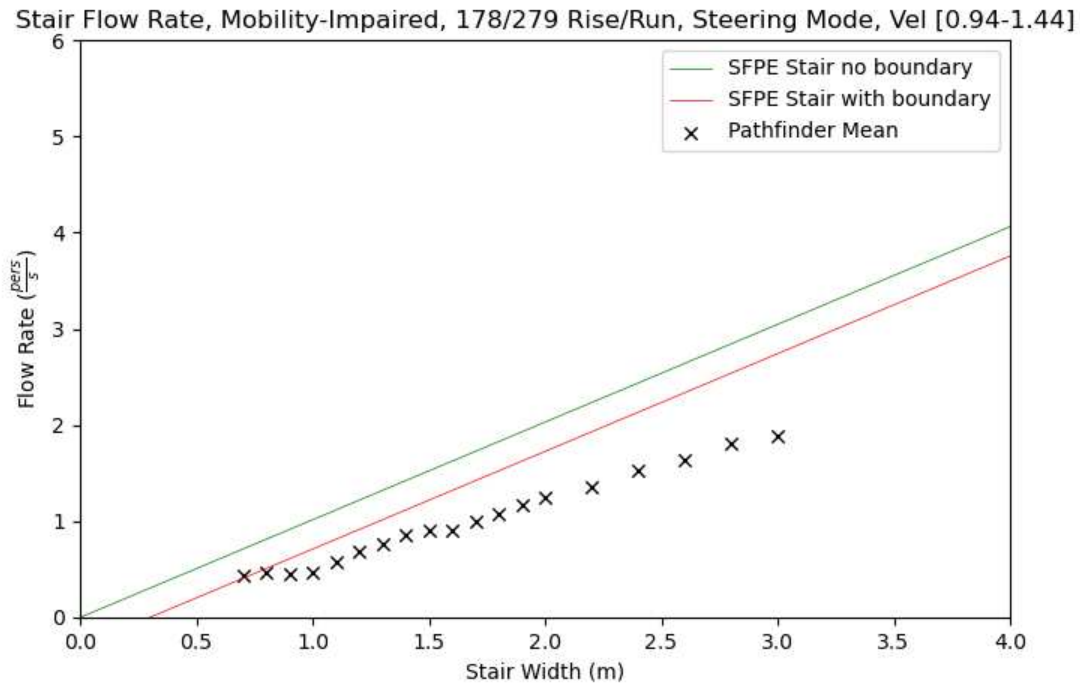

Figure 92. Stair flow rates for Steering mode, 90 percent of occupants have a max speed distribution of 1.19 ± 0.25 m/s, 10 percent have a constant speed of 0.5 m/s.

4.5.4. Analysis

The presence of mobility-impaired occupants reduces the stair flow rates (compare with Figure 50). No experimental data is available for comparison, but the trend is reasonable.

4.6. Elevator loading

This problem tests elevator loading.

4.6.1. Background

100 occupants are located in a 10x10 m room at an elevation of 10 m. The occupants exit using an elevator with dimensions 2 m wide and 1.7 m deep, for a typical elevator loading of about 16 people (Klote and Alvard 1992) and the elevator door width is 1.2 m. The elevators have an Open+Close Time of 7.0 s, Pickup and Discharge times of 10.0 s, and Open and Close delays of 5.0 s (see the Pathfinder User Manual for more information). There are four elevators, with specified Nominal Loads of 5, 10, 20, and 50 persons (Figure 93).

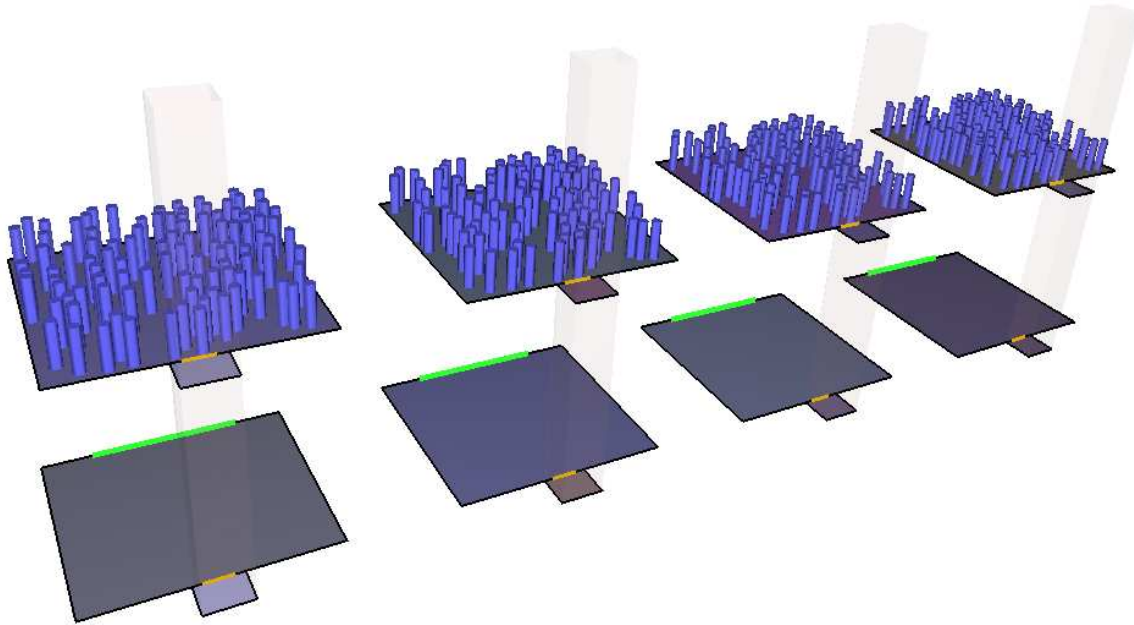

Figure 93. Elevator loading test

4.6.2. Setup Notes

The four problems are independent, so allow a quick verification.

4.6.3. Results

The resulting elevator loads for the steering simulation are shown in [Figure 94](#) and match the expected results. The results for Steering+SFPE and SFPE modes also matched the expected results.

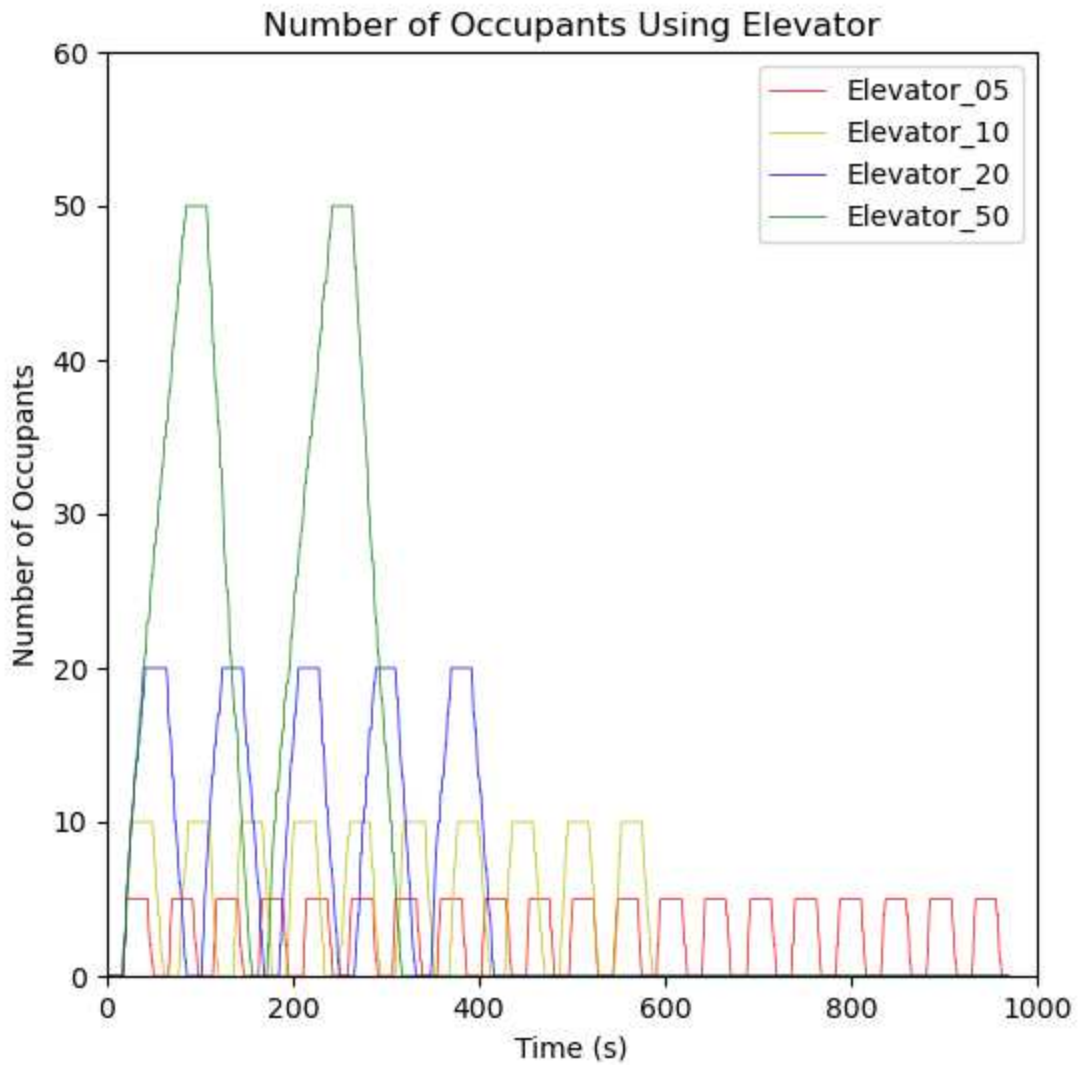

Figure 94. Observed elevator loading for steering mode

4.6.4. Analysis

The elevator loadings matched the expected values.

4.7. Use of Corridor during Cornering

This example tests the use of the corridor width while cornering.

4.7.1. Background

The example was originally presented in the FDS+Evac Technical Reference and User's Guide (Korhonen 2018). The problem describes an assembly space filled with 1000 occupants. The initial room measures 50 m x 60 m. At the right, there is a 7.2 m doorway leading to a 7.2 m corridor. The corridor contains a sharp turn to the left before continuing to the exit.

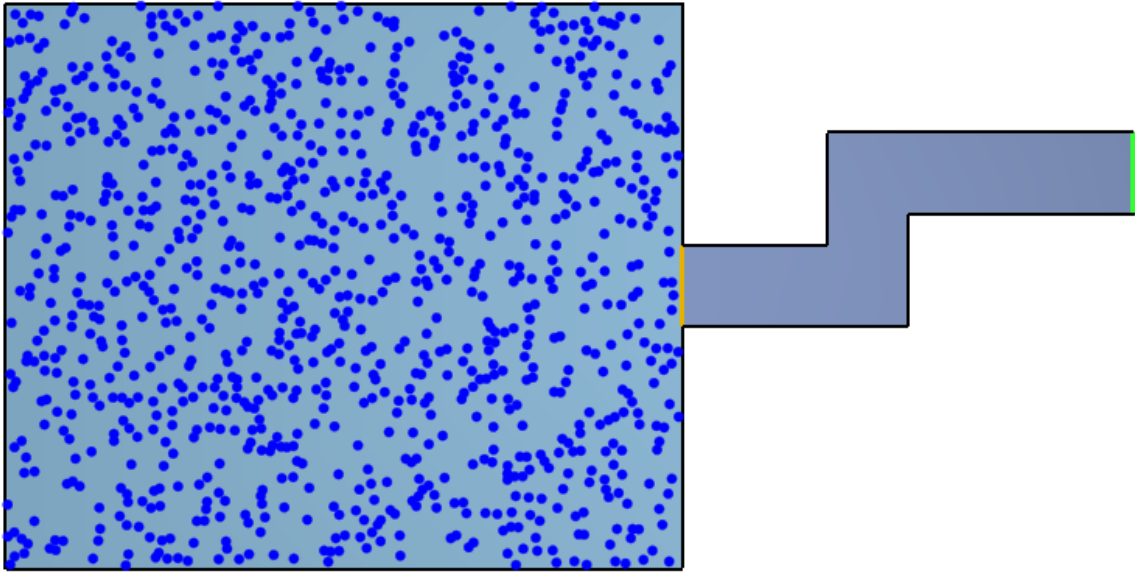

Figure 95. Initial configuration of the assembly space

The feature of interest in this problem is the corner in the corridor. Based on how different simulators handle the flow of large groups around a corner, different simulators can produce substantially different answers. Notably, the current body of movement research presents us with little guidance toward a "correct" solution to this problem.

4.7.2. Setup Notes

In addition to the two-corner problem, we simulated a single corner and a straight corridor without a corner. Only steering mode results are presented, since that is the case for which the corner slows movement.

4.7.3. Results

The primary interest is in how effectively the simulator uses the full width of the corridor and corner, Figure 96. In the Pathfinder simulation, there is some grouping that occurs in the vertical section of the corridor. This is a result of increased density which leads to slower movement.

The time for all occupants to exit was 164 seconds for the straight corridor, 163 seconds for one corner, and 185 seconds with two corners.

The model with a straight corridor has a 7.2 m wide corridor and a path length from the room to the exit of 41.5 m. An SFPE calculation using the flow rate and walking speeds at a density of 1.88 pers/m² and gives a total time of 171 seconds.

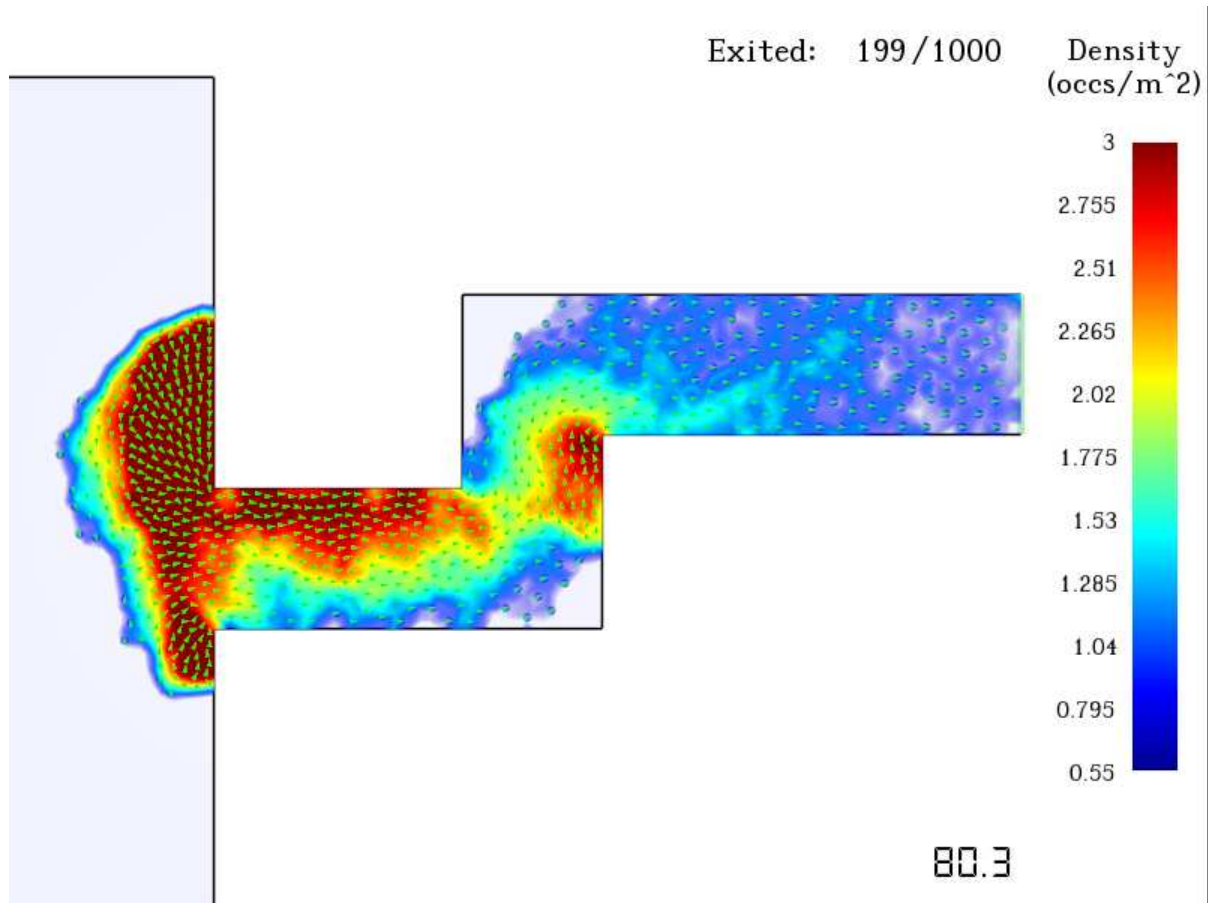

Figure 96. Steering mode showing use of the corridor with two corners.

4.7.4. Analysis

The Pathfinder results are reasonable.

Chapter 5. Special Program Features

5.1. Assisted Evacuation

5.1.1. Movement Speed on Level Surface

This test verifies that during assisted evacuation, the speed of the person being assisted controls the movement speed.

5.1.1.1. Background

The problem consists of a corridor, with the assistants at one end and the patient needing assistance located at the center of the corridor. The assistants first move independently to the patient, then they assist the patient to the exit. Initially, the assistants will use their independent walking speeds, but when assisting will use the patient speed.

5.1.1.2. Setup Notes

Figure 97 shows the test geometry. The default speed of the assistants is 1.19 m/s and the speed of the bed is 1 m/s.

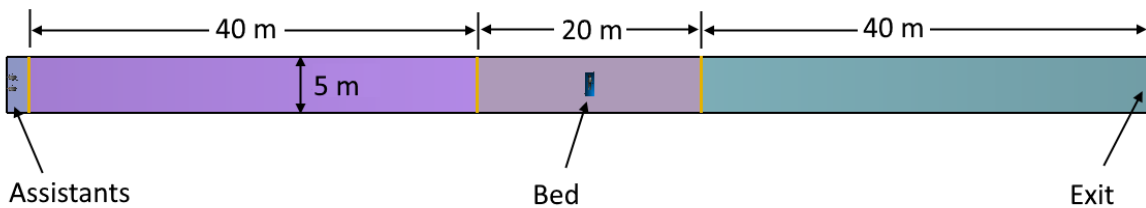

Figure 97. Test of assisted evacuation movement speed.

5.1.1.3. Results

The speed of the assistants moving independently and assisting the bed occupant are shown in Table 2. This data was taken from the occupant csv output file.

Table 2. Movement speed in different states.

Mode	Speed Independent (m/s)	Speed Assisting (m/s)
Steering	1.19	1.0
SFPE	1.19	1.0
Steering+SFPE	1.19	1.0

5.1.1.4. Analysis

All cases correctly show the specified independent walking speed and that the speed changes to the bed speed when assisting the bed occupant.

5.1.2. Stairway Speed Up

This test verifies that during assisted evacuation, the speed of the person being assisted controls the movement speed up stairs.

5.1.2.1. Background

This test is similar to the level surface test, except the occupants now move up stairs that have a rise of 17.5 cm and a run of 29.0 cm.

5.1.2.2. Setup Notes

The width of the stairs was 1.1 m. The total horizontal distance of the stairs is 40 m and the vertical distance is 24 m, so the diagonal distance on the stairs is 46.64 m. The patient speed up the stairs was specified as 0.3 m/s.

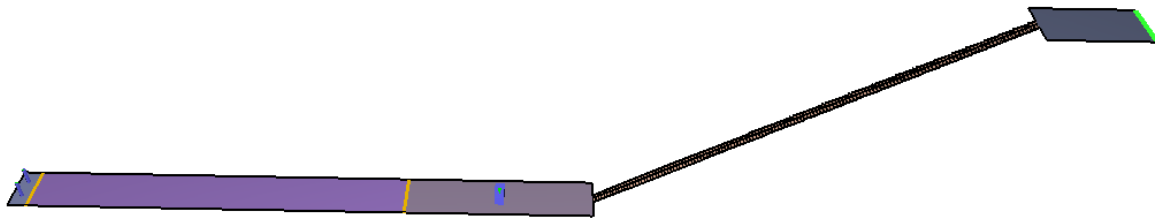

Figure 98. Model for assisted evacuation movement up stairs.

5.1.2.3. Results

The speed of the assistants moving independently and assisting the bed occupant up the stairs are shown in the following table. This data was taken from the occupant csv output file.

Table 3. Movement speeds assisting up stairs.

Mode	Speed Independent (m/s)	Speed Assisting (m/s)
Steering	1.19	0.3
SFPE	1.19	0.79
Steering+SFPE	1.19	0.3

5.1.2.4. Analysis

All cases correctly show the specified independent walking speed. For SFPE mode, the speed up the stair is defined by the SFPE correlation and not the user input.

5.1.3. Stairway Speed Down

This test verifies that during assisted evacuation, the speed of the person being assisted controls the movement speed down stairs.

5.1.3.1. Background

This test is similar to the level surface test, except the occupants now move down stairs that have a rise of 17.5 cm and a run of 29.0 cm.

5.1.3.2. Setup Notes

The width of the stairs was 1.1 m. The total horizontal distance of the stairs is 40 m and the vertical distance is 24 m, so the diagonal distance on the stairs is 46.64 m. The speed down the stairs was specified as 0.5 m/s.

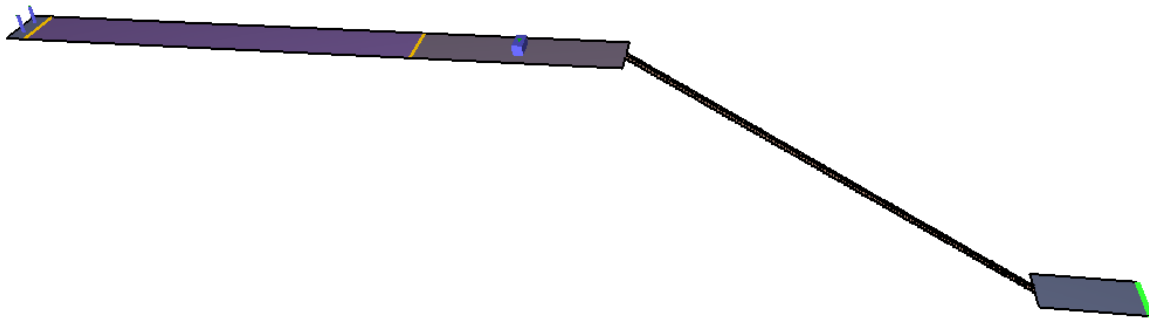

Figure 99. Model for assisted evacuation movement down stairs.

5.1.3.3. Results

The speed of the assistants moving independently and assisting the bed occupant down the stairs are shown in the following table. This data was taken from the occupant csv output file.

Table 4. Movement speeds assisting down stairs.

Mode	Speed Independent (m/s)	Speed Assisting (m/s)
Steering	1.19	0.5
SFPE	1.19	0.79
Steering+SFPE	1.19	0.5

5.1.3.4. Analysis

All cases correctly show the specified independent walking speed. For SFPE mode, the speed down the stair is defined by the SFPE correction and not the user input.

5.1.4. Team Assignment

This test verifies the capability to assign assistants to teams and then assign occupants that need evacuation assistance to be assisted by specific teams.

5.1.4.1. Background

There are seven assistants: five assigned to the red team and two to the blue. The occupants that need assistance are divided equally, so that six will be assisted by the red team and six by the blue.

5.1.4.2. Setup Notes

[Figure 100](#) shows the model used to test the assignment of assist teams. The smaller occupants needing assistance are wheelchairs and the larger are beds. Each team is assigned to evacuate the wheelchairs first, then the beds.

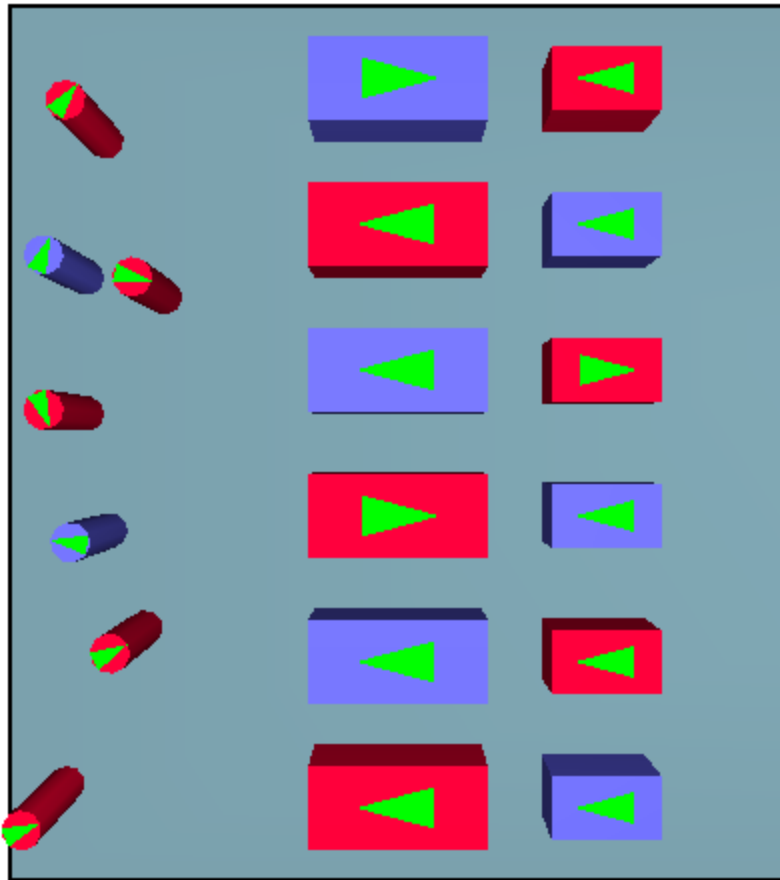

Figure 100. Model to test assignment of different assistant teams to occupants needing assistance.

5.1.4.3. Results

Figure 101 shows the result early in the evacuation, the wheelchairs are being assisted first. Three members of the red team are assisting wheelchairs, so the other two red team members are assisting the bed. The two blue team members are assisting wheelchairs. For assisted occupants, if a path is blocked, the assisted beds (or other vehicle) are briefly represented as cylinders to allow some overlap with the blocking wheelchairs (vehicles).

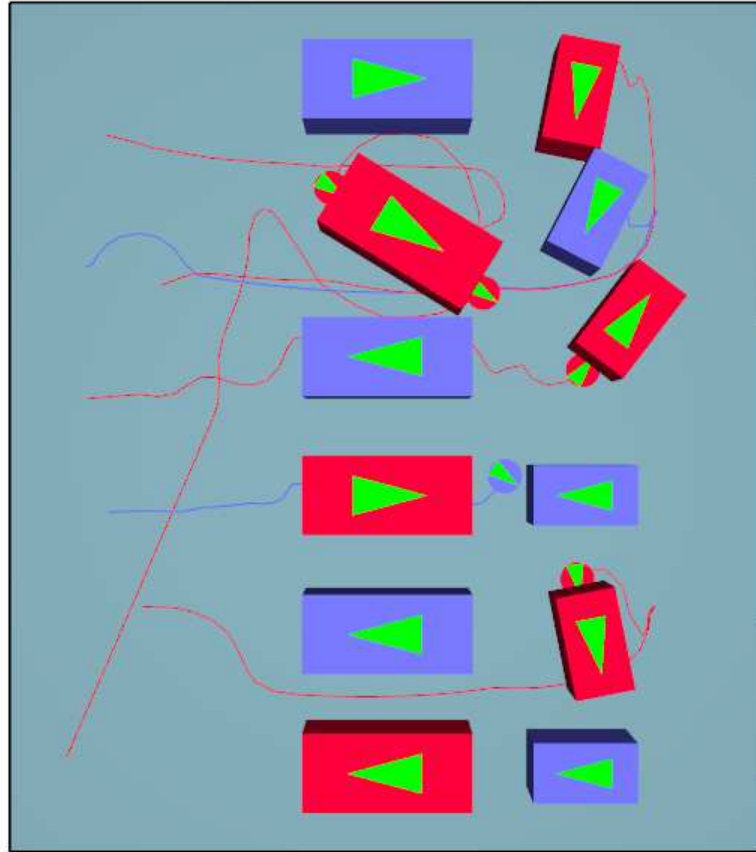

Figure 101. Solution at 10 seconds. Note that the order of evacuation was wheelchairs first.

Figure 102 shows the movement near the end of the simulation. Notice that the red occupants needing assistance have been nearly all helped. It takes longer to assist the blue occupants, since there are only two members in the blue team.

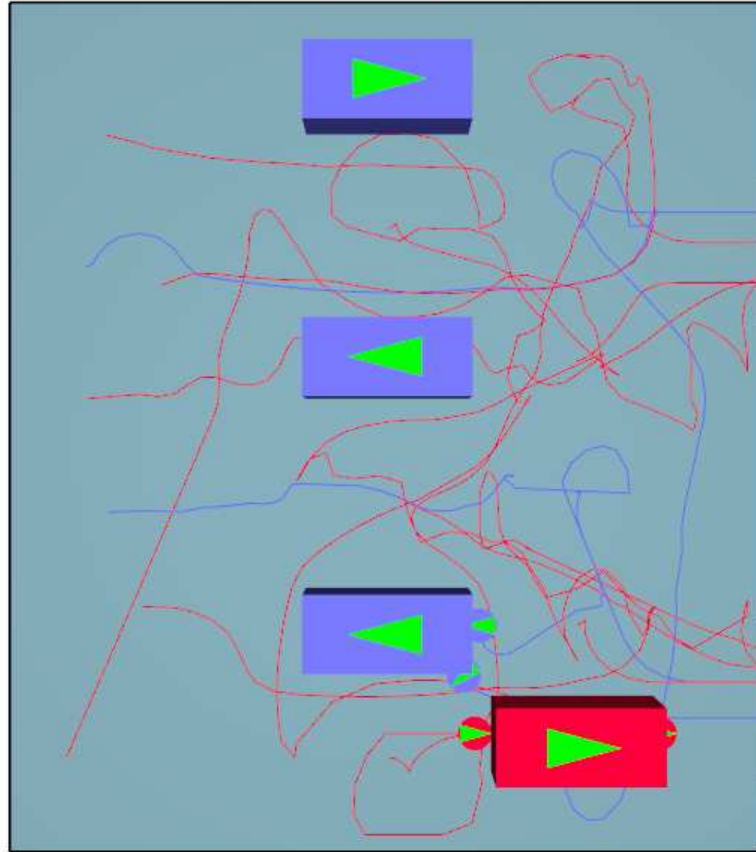

Figure 102. Movement at 27 seconds, near end of simulation.

5.1.4.4. Analysis

Assistants in the red team evacuated only red occupants and the blue team evacuated only blue occupants. Assisting the blue occupants took longer, since there were fewer members in the blue team.

The beds and wheelchairs moved as expected, avoiding other beds and wheelchairs when possible and, if blocked, briefly allowing some overlap.

When each team completed the assigned tasks, they exited.

The assistance behavior is as expected.

5.1.5. Ghent Hospital Simulation

This test replicates a simulation of evacuation from the 11th floor of a hospital, as described in a paper by Hunt, et al. (Hunt, Galea, and Lawrence 2013).

5.1.5.1. Background

As described in the paper, "Data were collected from 32 trials in which a test subject was evacuated through 11 floors of Ghent University Hospital using four commonly used movement assistance devices: stretcher, carry chair, evacuation chair and rescue sheet." Using this data, simulations of the evacuation of 28 patients were made using different devices, different numbers of staff, and male/female teams.

We will replicate two scenarios:

1. The day shift female team using evacuation chairs
2. The night shift male team using stretchers.

5.1.5.2. Setup Notes

Figure 103 shows the basic geometry of the hospital floor to be evacuated. In this figure, some of the dimensions such as corridor door widths have been estimated by scaling the drawing.

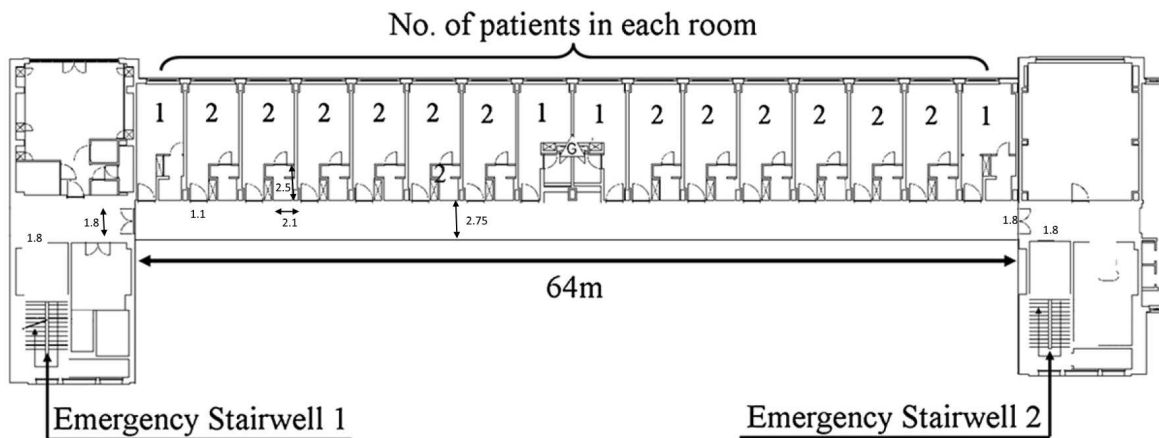

Figure 103. Geometry of floor 11 with patients (Hunt, Galea, and Lawrence 2013).

Figure 104 shows the geometry of the stairs. Key dimensions of the stairs are that each step has a rise of 17.5 cm and a run of 29 cm, there are 12 rises in each flight of stairs (this model neglected the detail that flights between floors 2 and 3 have only 10 risers), and the width of the stairs are 1.4 m between the handrails.

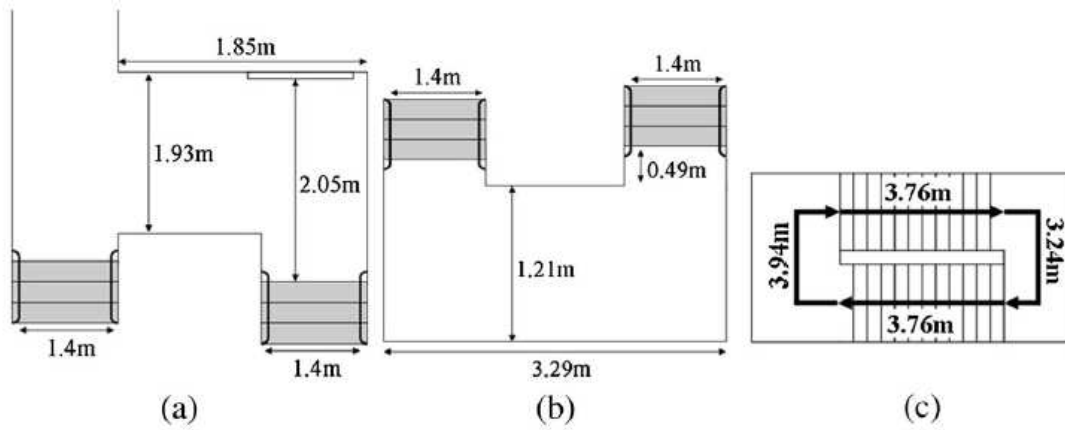
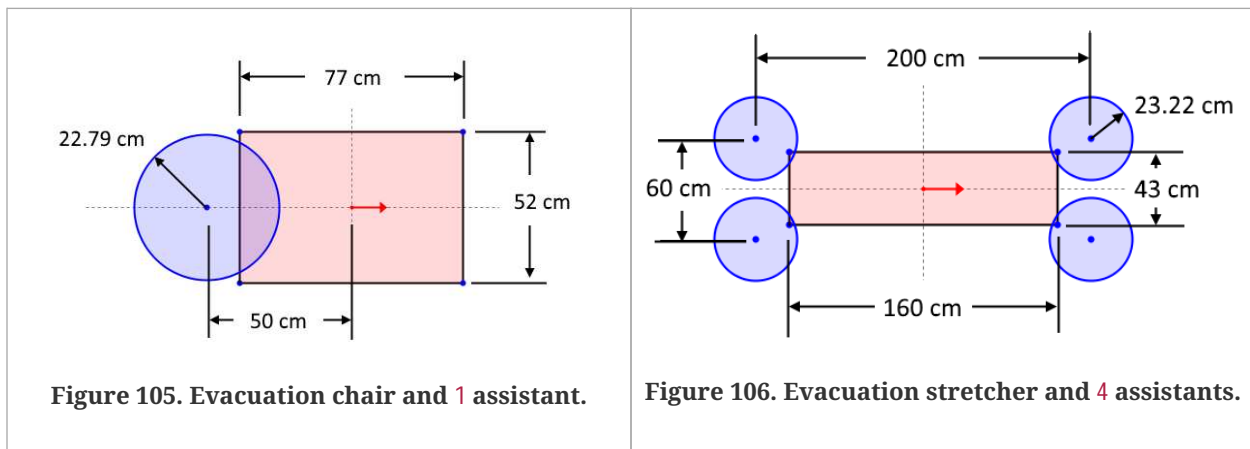

Figure 4. Stair dimensions.

Figure 104. Stair geometry (Hunt, Galea, and Lawrence 2013).

The geometry of the evacuation chair (Figure 105), evacuation stretcher (Figure 106), and assistant positions are shown below.



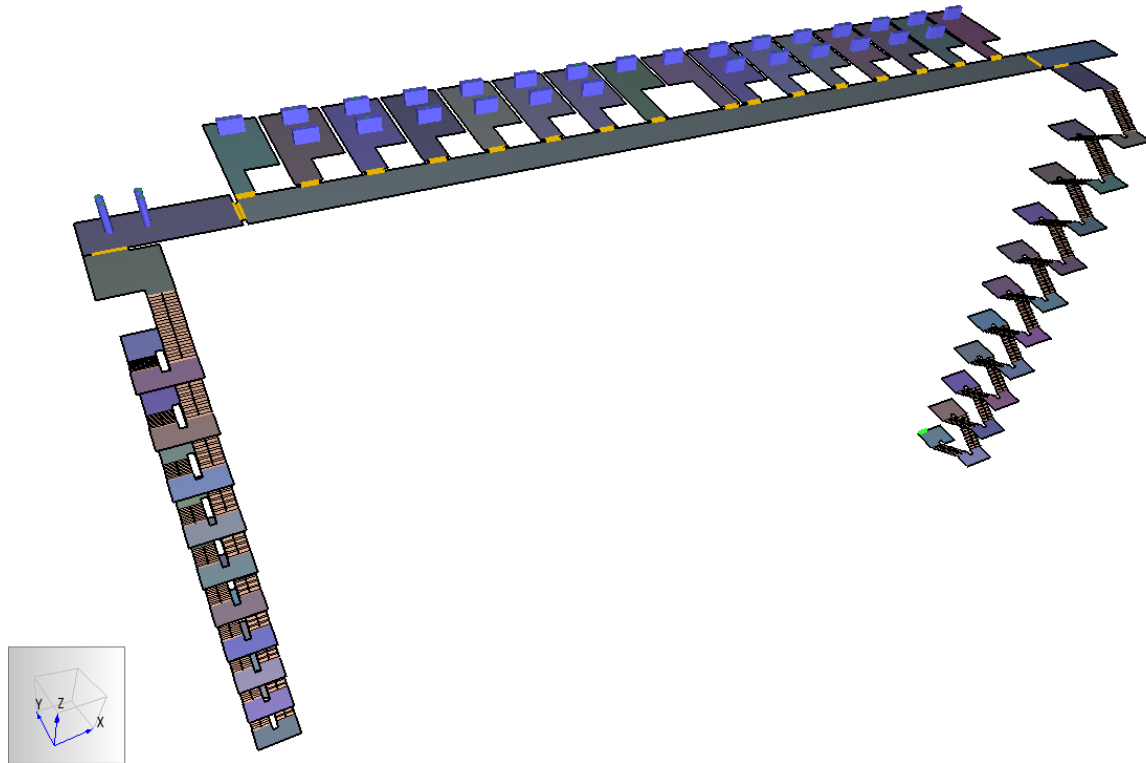

Figure 107. Ghent Hospital simulation for stretcher evacuation with four members in evacuation team.

Table 5 gives the speeds for the patients and assistants.

Table 5. Speeds used in evacuation simulations

Role	Horizontal (m/s)	Stair Down (m/s)	Stair Up (m/s)	Initial Delay (s)
Stretcher (male team)	1.09 ±0.08	0.63	N/A	67.6
Evacuation Chair (female team)	1.39 ±0.03	0.82	N/A	35.9
Female and Male Assistants	1.385±0.055	0.885±0.125	0.655±0.015	0.0

5.1.5.3. Results for Single Patient Evacuation

Before proceeding to the full evacuation simulation, we first model evacuation of one patient, either in an evacuation chair or stretcher. This allows us to compare to hand calculations.

The first case is one evacuation chair and one female assistant. Table 6 compares results for a hand calculation and Pathfinder (in steering mode and based on nominal speeds given above and distances in the model). The hand calculations do not include any factors such as delay for door

opening, cornering speeds, or fatigue. The Pathfinder calculations do include delays and extra movement due to cornering and, as a result, are slower than the hand calculation. For SFPE mode, the stair speeds use the SFPE stair speed factor.

Table 6. Hand calculated travel distances and time for evacuation chair.

Evacuation Phase	Steering Mode			SFPE Mode		
	Speed (m/s)	Distance	Time (s)	Speed (m/s)	Distance	Time (s)
Assistant to Patient	1.385	25.9	18.7	1.385	25.9	18.7
Preparation		0.0	35.9		0.0	35.9
Patient to Stairs	1.390	34.5	24.8	1.390	34.5	24.8
Patient down 20 runs of stairs	0.820	76.4	93.1	1.070	76.4	71.4
Patient on 20 landings	1.390	46.0	33.1	1.390	46.0	33.1
Patient on bottom landing	1.390	2.4	1.7	1.390	2.4	1.7
Assistant on bottom landing	1.385	2.4	1.8	1.385	2.4	1.8
Assistant up 20 runs of stairs	0.655	76.4	116.6	1.070	76.4	71.4
Assistant on 20 landings	1.385	43.8	31.6	1.385	43.8	31.6
Assistant return to start	1.385	7.9	5.7	1.385	7.9	5.7
Hand calculation single trip totals:		315.6	363.0		315.6	296.1

Pathfinder:			407.52			302.11
--------------------	--	--	---------------	--	--	---------------

The second case is one stretcher with four male assistants. Again, we compare hand calculations with Pathfinder, [Table 7](#). As before, the Pathfinder calculations are slower than the hand calculation. In this case there is additional difficulty maneuvering the stretcher through doors and on the landings. For SFPE mode, the stair speeds use the SFPE stair speed factor.

Table 7. Hand calculated travel distances and time for stretcher.

Evacuation Phase	Steering Mode			SFPE Mode		
	Speed (m/s)	Distance	Time (s)	Speed (m/s)	Distance	Time (s)
Assistant to Patient	1.385	25.9	18.7	1.385	25.9	18.7
Preparation		0.0	67.6		0.0	67.6
Patient to Stairs	1.090	34.5	31.7	1.090	34.5	31.7
Patient down 20 runs of stairs	0.630	76.4	121.2	0.840	76.4	90.9
Patient on 20 landings	1.090	46.0	42.2	1.090	46.0	42.2
Patient on bottom landing	1.090	2.4	1.8	1.385	2.4	1.8
Assistant on bottom landing	1.385	2.4	1.8	1.385	2.4	1.8
Assistant up 20 runs of stairs	0.655	76.4	116.6	1.070	76.4	71.4
Assistant on 20 landings	1.385	43.8	31.6	1.385	43.8	31.6
Assistant return to start	1.385	7.9	5.7	1.385	7.9	5.7

Hand calculation single trip totals:		315.7	439.3		315.7	363.7
Pathfinder:			534.0			457.63

5.1.5.4. Results for Floor Evacuation

Two scenarios were used for the evacuation of all occupants on the floor:

1. A day shift female team using evacuation chairs
2. A night shift male team using stretchers.

In the hospital, the day shift team consists of seven assistants. Preparation for evacuation using the evacuation chair requires two assistants but only one assistant is needed during evacuation movement of the chair. To represent this, the simulation for the evacuation chair assumed that one assistant was always occupied with helping prepare occupants and that only six assistants participated in the evacuation movement. For the night shift there are only four assistants and each stretcher requires four assistants during evacuation.

Table 8 summarizes the calculated results. The hand calculation was based on calculations shown in Table 6 and Table 7.

Table 8. Summary of evacuation results. Exodus results are from Hunt, et al. (Hunt, Galea, and Lawrence 2013).

Simulation	Steering Mode		SFPE Mode		Pathfinder Steering+SF PE (hr)	Exodus (hr)
	Pathfinder (hr)	Hand Calculation (hr)	Pathfinder (hr)	Hand Calculation (hr)		
Evac chair, female team, 6 assistants	0.52	0.46	0.39	0.38	0.54	0.6
Stretcher, male team, 4 assistants	4.17	3.37	3.61	2.80	4.27	3.8

5.1.5.5. Analysis

The results are consistent with the hand calculation, in that all Pathfinder calculations are slightly longer than the hand calculations. The SFPE results are shorter than the Steering results primarily

because the stair speeds down and up use the faster SFPE stair speed factors. The results are also similar to the Exodus results.

5.2. Source Flow Rates

This tests the flow rates of occupant sources. Sources can be used to introduce new occupants into a simulation.

5.2.1. Background

Sources can be assigned to: a rectangular area, rooms, and doors (both internal and exit).

Source parameters include: flow rate (constant or periodic), the profile distribution, the behavior of occupants, and an option to either delay introducing occupants into a crowded room or to enforce the flow rate (even if that will result in overlapping occupants).

5.2.2. Setup Notes

The model is shown in [Figure 108](#). Four source types were tested: rectangle, door, exit door, and room. The occupants were distributed uniformly between two profiles (red and blue). The source flowrate is constant at 2.5 pers/s. The Enforce Flowrate option was selected.

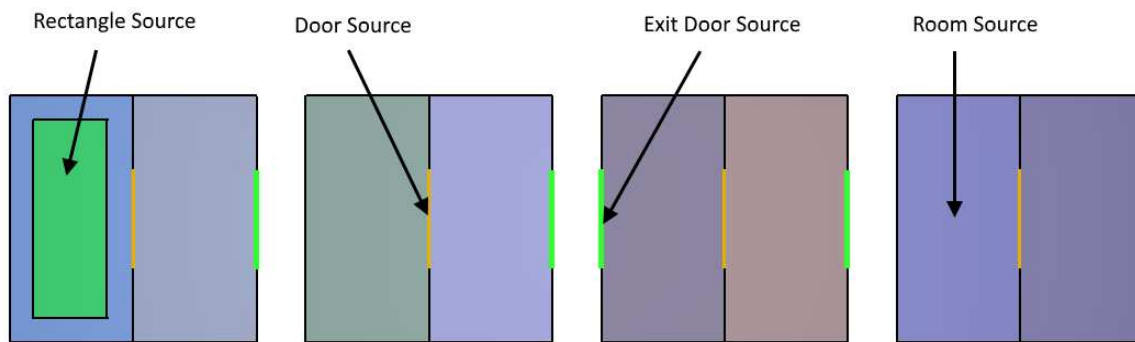

Figure 108. Model used to test occupant sources.

5.2.3. Results

[Figure 109](#) shows the exit door flow rates for the four cases. In all cases, the flow reaches a steady-state value of 2.5 pers/s. Results for steering behavior (shown), SFPE and Steering+SFPE are similar.

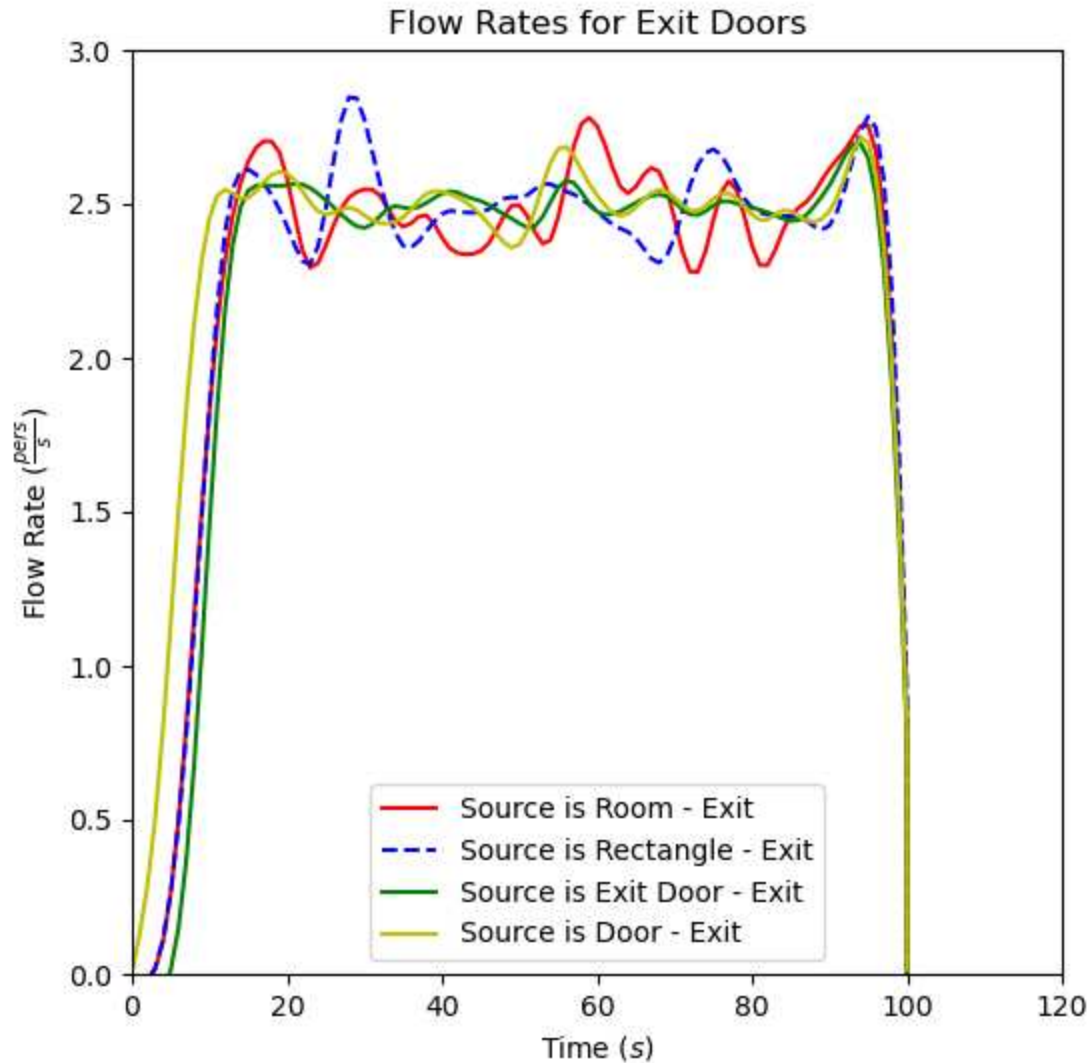

Figure 109. Exit door flow rates for the different source types.

5.2.4. Analysis

The Pathfinder calculations performed as expected.

5.3. Fractional Effective Dose (FED) Calculation

The Pathfinder calculation of Fractional Effective Dose (FED) uses the equations described in the SFPE Handbook of Fire Protection Engineering, pages 2308-2428 (SFPE 2016).

5.3.1. Background

The implementation is the same as used in FDS+EVAC (Korhonen 2018), using only the concentrations of the narcotic gases [stem f74275c195a72099e0b06f584fd5489a], [stem 8306272097a2ac71e3c568c80d48b7f9], and [stem adae461c37eccd2f2a6ed21ebf2c5d08] to calculate the FED value.

[stem d32742e43e1d85cd024c9cd03709172b]

This calculation does not include the effect of hydrogen cyanide (HCN) and the effect of [stem 8306272097a2ac71e3c568c80d48b7f9] is only due to hyperventilation.

See the Pathfinder [User Manual](#) and [Technical Reference Manual](#) for more details.

5.3.2. Stationary Occupant

5.3.2.1. Setup Notes

This validation problem tests the calculation of FED for a stationary occupant. The PyroSim model is shown in [Figure 110](#). The model includes a fire and devices that measure the volume fractions of [stem f74275c195a72099e0b06f584fd5489a], [stem 8306272097a2ac71e3c568c80d48b7f9], and [stem adae461c37eccd2f2a6ed21ebf2c5d08] at the location of the height of the occupant. The model also uses FDS to calculate FED which is compared to the Pathfinder calculation.

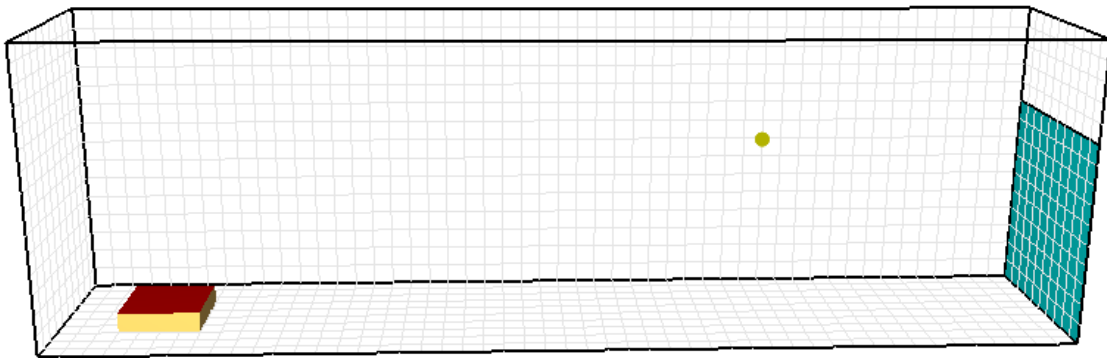

Figure 110. PyroSim model of FED calculation using stationary occupant.

The Pathfinder model is shown in [Figure 111](#). Pathfinder samples FED quantities at 90% of occupant height. The default height is 1.8288 m, so devices are located at a height of 1.6459 m in the PyroSim model.



Figure 111. Pathfinder model of FED calculation using stationary occupant.

5.3.2.2. Results

Comparisons of the FDS device outputs and the Pathfinder inputs and calculated FED are shown in Figure 112, Figure 113, Figure 114, and Figure 115. Pathfinder reads 3D Plot data and then interpolates, so there is some difference between the device and interpolated values for [stem 8306272097a2ac71e3c568c80d48b7f9], [stem f74275c195a72099e0b06f584fd5489a], and [stem adae461c37eccd2f2a6ed21ebf2c5d08].

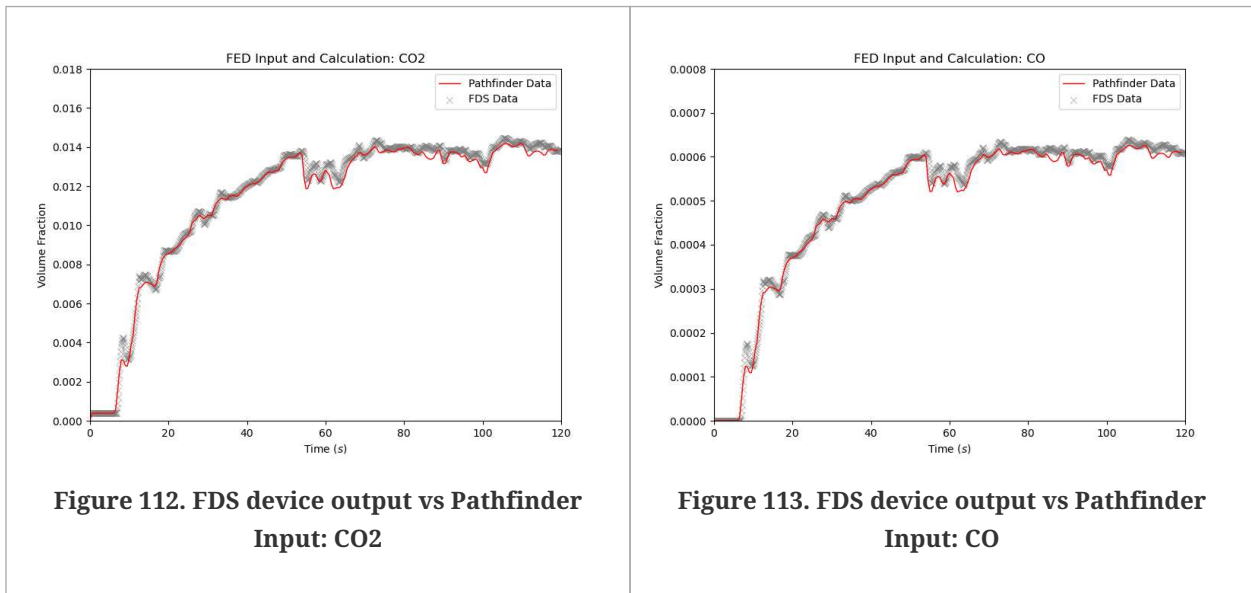

Figure 112. FDS device output vs Pathfinder Input: CO2

Figure 113. FDS device output vs Pathfinder Input: CO

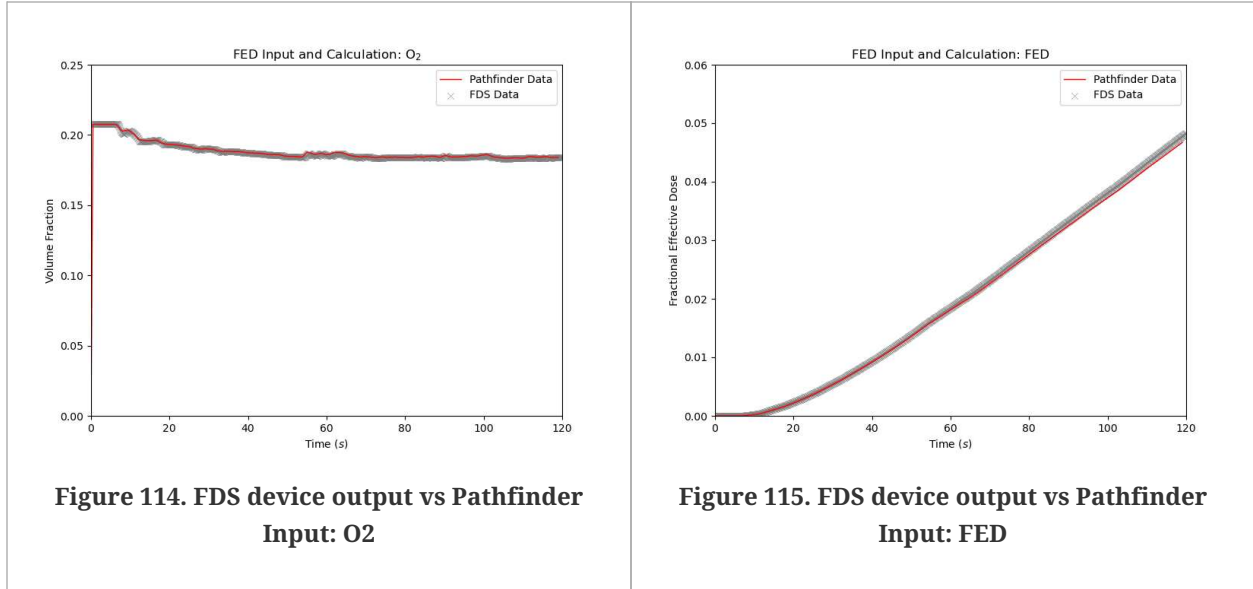

Figure 114. FDS device output vs Pathfinder Input: O₂

Figure 115. FDS device output vs Pathfinder Input: FED

5.3.2.3. Analysis

As noted, the 3D Plot data output from FDS is somewhat different from the device output. In addition, the 3D Plot data was output at a time interval of 0.5 seconds, so the FED time integration results in some difference with the FDS device value integrated at a finer time step. The final values are $FED=0.0467$ for FDS and $FED=0.0455$ for Pathfinder (3% difference).

The Pathfinder results are satisfactory.

5.3.3. Moving Occupant

5.3.3.1. Setup Notes

This validation problem tests the calculation of FED for a moving occupant. The PyroSim model is shown in Figure 116. The model is divided into three initial (INIT) regions separated by thin wall obstructions.

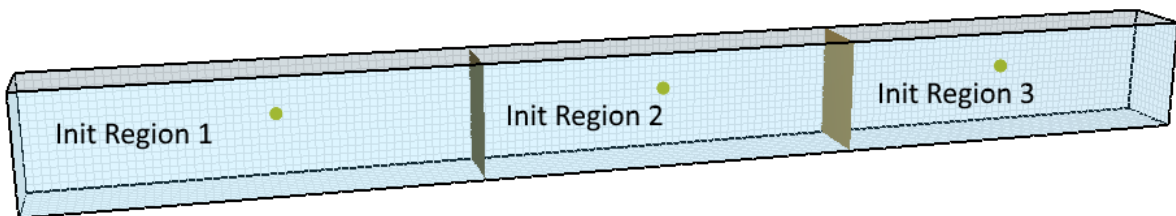

Figure 116. PyroSim model of FED calculation for moving occupant.

The init regions used a mix of air and combustion products. The mass fractions of species in the two mixtures are shown in Table 9. Init Region 1 has 100% mass fraction combustion products, Init Region 2 has 75% combustion products and 25% air, and Init Region 3 has 50% combustion products

and 50% air.

Table 9. Species in gas mixtures.

Species	Combustion Products	AIR
Carbon Dioxide	0.010000	0.000592
Carbon Monoxide	0.001000	0.000000
Nitrogen	0.839000	0.763018
Oxygen	0.150000	0.231164
Water Vapor	0.000000	0.005226

The Pathfinder model is shown in [Figure 117](#). The occupant starts on the left and has a velocity of 0.25 m/s. The distance to the exit is 30 m, so the time to exit is approximately 120 seconds (there is some acceleration time at the start). As the occupant moves through the model, they are exposed to the different gas mixtures.



Figure 117. Pathfinder model of FED calculation using moving occupant.

5.3.3.2. Results

Comparisons of the FDS device outputs and the Pathfinder inputs and calculated FED are shown in [Figure 118](#), [Figure 119](#), [Figure 120](#), and [Figure 121](#). The data shows how the occupant is exposed to different concentrations as they move through the model.

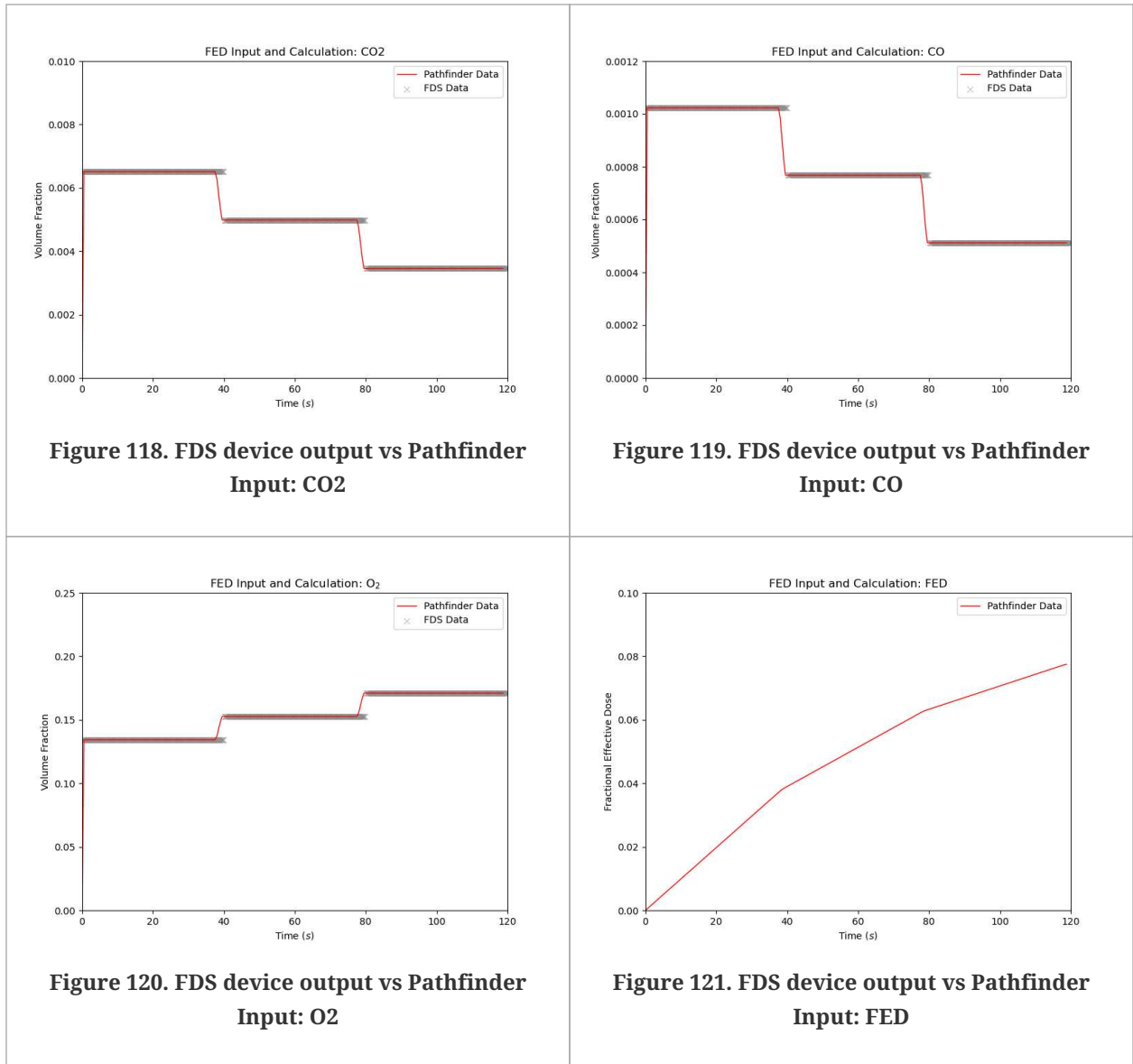

5.3.3.3. Analysis

For this simulation, the concentrations are constant over each initial region. We can calculate the expected FED by hand to be 0.07896. Pathfinder calculates 0.07745, a difference of 1.9%. As can be seen in Figure 121, the Pathfinder interpolation of the 3D Plot data leads to a smoothing of the data at the region boundaries.

The Pathfinder results are satisfactory.

5.4. Walking Speed Reduction Due to Smoke

5.4.1. Background

The Pathfinder calculation of speed reduction due to smoke is based on a paper by Fridolf, Nilsson, Ronchi, and Frantzich (2019). The walking speed reduction factor [stem 2a98e1288a7f7c95659d41ddf6e52c36] is a function of visibility x [m] as shown in [Figure 122](#). The equation for the reduction factor is given by:

$$w_f = \min(1, \max(0.2, 1 - 0.34 * \left(3 - x\right)))$$

../../../../../../../../includes/images/stem-6ccd8abed9f3709e1d99a72b3fba9377.png

The maximum walking speed of the occupant is reduced by the walking speed reduction factor.

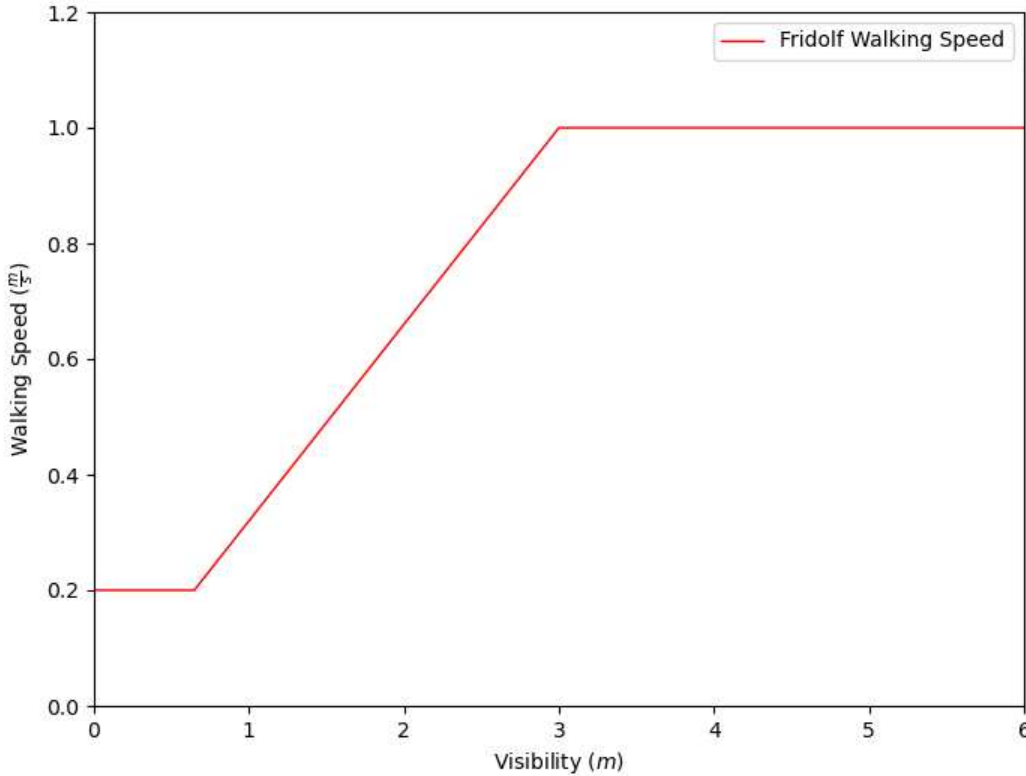

Figure 122. Speed Reduction in Smoke (Fridolf et al. 2019)

To use this feature, it is necessary to first run a PyroSim simulation that calculates visibility. The visibility data is then imported into Pathfinder. The data is extracted for each occupant at their X-Y location and a Z height of 90% of the occupant height. See the [Pathfinder User Guide](#) and [Pathfinder Technical Reference](#) for more details.

5.4.2. Setup Notes

This validation problem tests speed reduction for occupants as they move through different visibilities. The PyroSim model consists of separated regions where the soot mass fraction is defined to give visibilities of 0.5 m, 1.0 m, 2.0 m, 3.0 m, 4.0 m, 5.0 m, and ∞ m.

The Pathfinder model is shown in [Figure 123](#). Each room has a uniform visibility that results from the soot density.

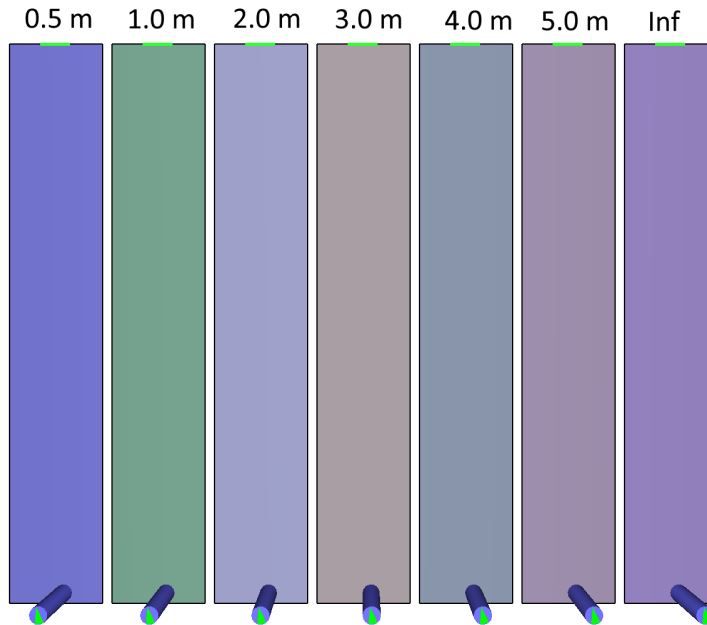

Figure 123. Pathfinder model to calculate speed in smoke. The values indicate visibility in the different rooms.

5.4.3. Results

A comparison of the calculated and expected speeds is shown in [Figure 124](#).

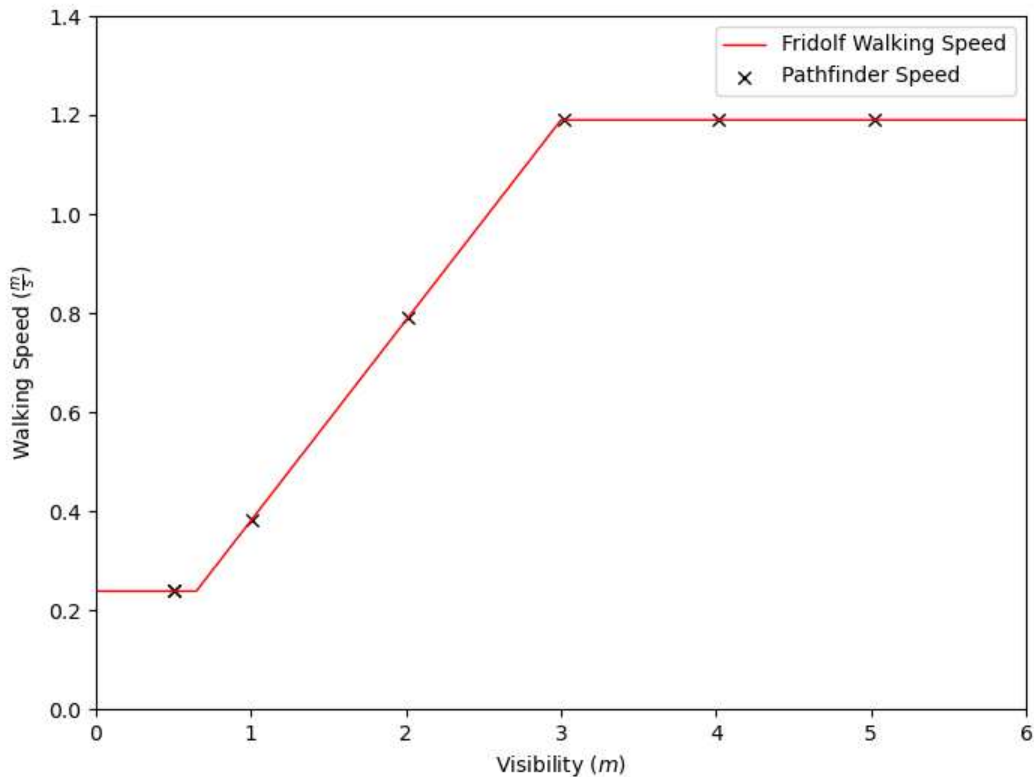

Figure 124. Comparison of expected and calculated speeds in smoke.

5.4.4. Analysis

The speeds in smoke calculated by Pathfinder are correctly calculated. The Pathfinder results are satisfactory.

5.5. Social Distancing

This test case verifies occupants ability to realistically maintain a specified social distance. The model is a $10\text{m} \times 10\text{m}$ room with a 1m door on the North side that is initially closed. The 8 uniformly distributed occupants in the room will wait and bunch up near the door while it is closed, and then at $t=10\text{s}$, when the door opens, will begin making their way out of the room. The data presented will be taken between 2s and 20s of simulation time, because outside of these times occupants are so distanced that they are outside of the maximum range for determining their nearest occupant.

5.5.1. Expected Results

Occupants are expected to maintain an average minimum separation distance of $\pm 15\%$ of the

specified social distance throughout the majority of the simulation. This range takes in to account the variances that might be expected of real social distancing scenarios (i.e. Not every occupant will maintain a perfect social distance at all times.)

5.5.2. Results

As can be seen in [Figure 125](#), Occupants maintained an average social distance inside the specified range for the majority of the simulation. The periods where the highest changes were experienced were during the beginning of the simulation, where occupants approached and began bunching up near the door while waiting for it to open, and after the door opened, where occupants began exiting through the door while the remaining occupants moved closer towards the door and took up the voided space to exit themselves.

[Figure 126](#) gives a good visual representation of what these encroachments look like. Occupants are shown as 3D models with 1m radius disks centered at occupant center.

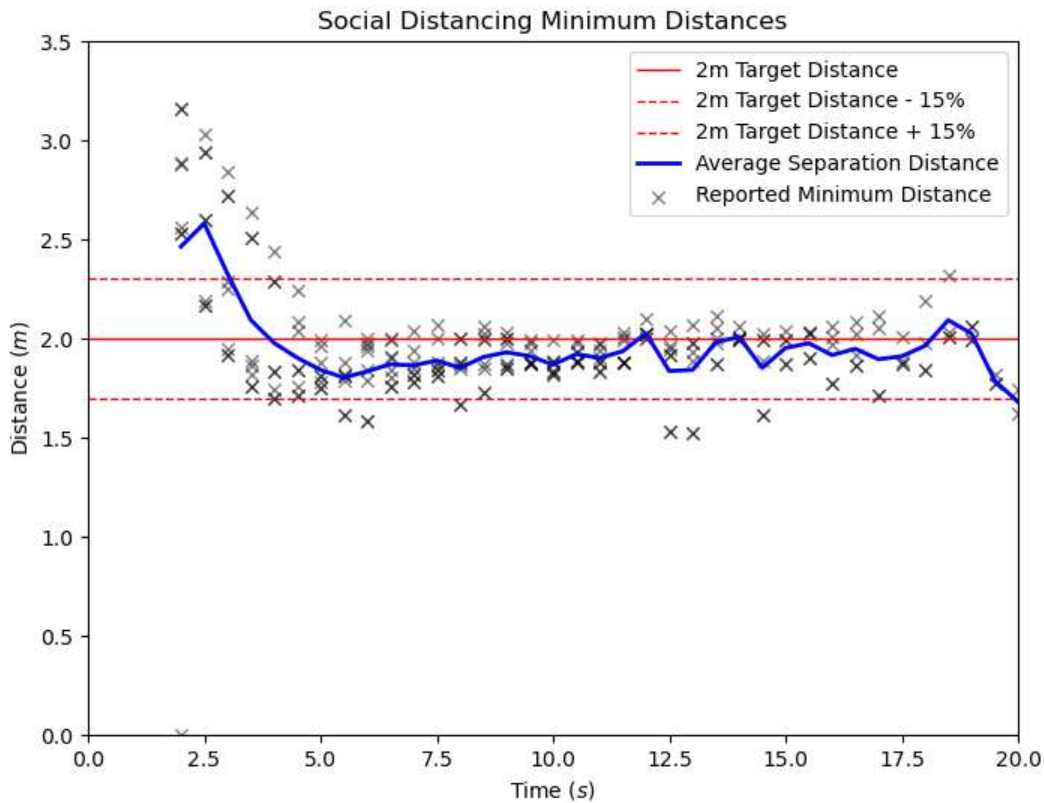

Figure 125. Social Distancing Test Results

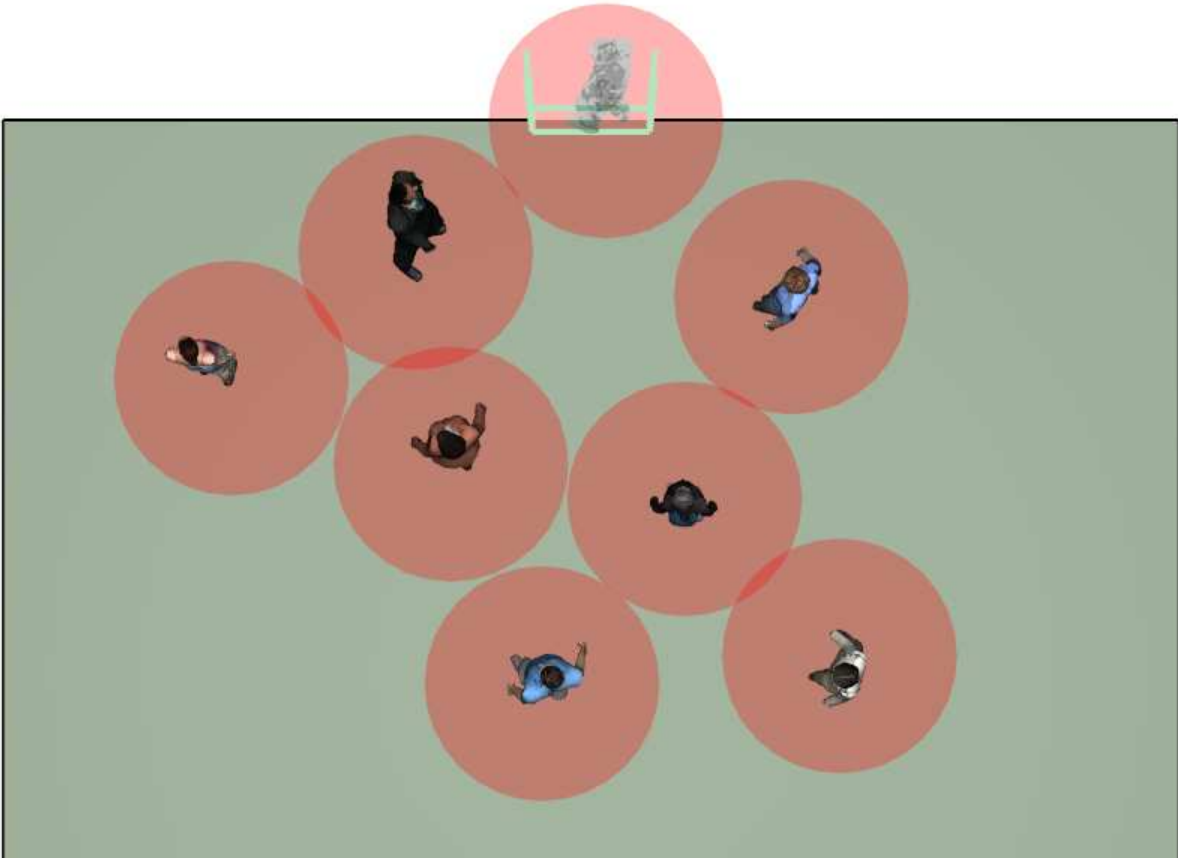

Figure 126. Screenshot of Occupants at t=11s with 1m radius disks at occupant centers

Chapter 6. IMO Tests

This section presents test cases described in Annex 3 of IMO 1533 (IMO 2016).

6.1. Movement Speed (IMO_01)

This test case verifies movement speed in a corridor for a single occupant. The test case is based on *Test 1* given in Annex 3 of IMO 1533 (IMO 2016). The test case describes a corridor 2 meters wide and 40 meters long containing a single occupant. The occupant must walk across the corridor and exit. The occupant's waking speed is 1.0 m/s.

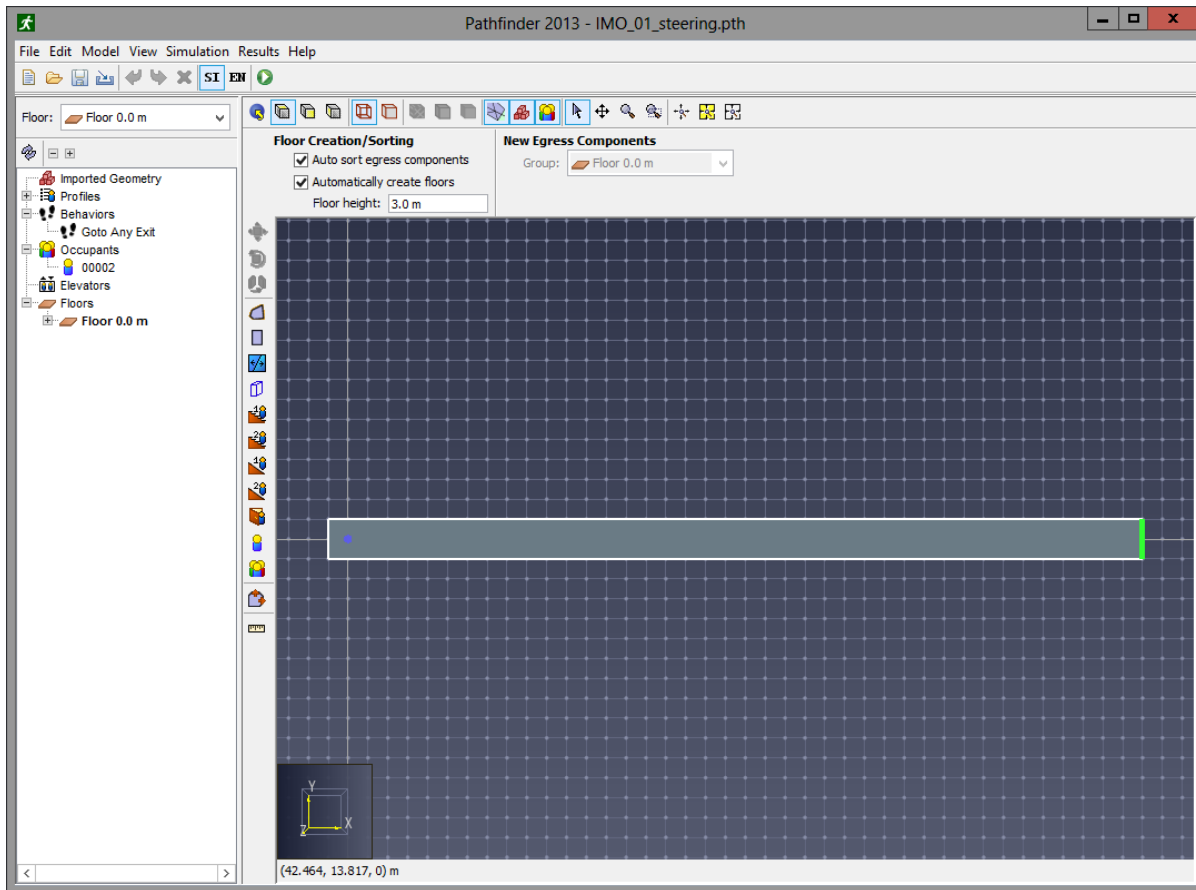

Figure 127. IMO_01 problem setup.

6.1.1. Setup Notes

Since Pathfinder tracks occupant location by the center point, the navigation mesh was extended 0.5 meters behind the occupant to allow space for the back half of the occupant when standing exactly 40 meters from the exit.

6.1.2. Expected Results

SFPE mode should give an exit time of 40.0 seconds.

Steering mode uses inertia and we need to account for the time it takes to accelerate to 1.0 m/s. Occupants in Pathfinder can accelerate to maximum speed in 1.1 s. From [stem 1f56771b66bea938023c68aec4126d5c] we know that with [stem d0623a3187b95ed8ba2dde54f038dae4], [stem cc4b4e89e716fb7692ed4e4d4422a2a3], at t=1.1 s the occupant will have travelled 0.55 m. The remaining 39.45 meters will be covered at 1.0 m/s. Thus, steering mode should give an exit time of 40.55 seconds.

6.1.3. Results

Table 10 shows the time to exit in each tested mode.

Table 10. IMO_01 Results

Mode	Time
Steering	40.55
Steering + SFPE	40.55
SFPE	40.02

6.1.4. Analysis

All test cases were successful.

6.2. Stairway Speed, Up (IMO_02)

This test verifies movement speed up a stairway for a single occupant. The test case is based on Test 2 given in Annex 3 of IMO 1533 (IMO 2016). The test case describes a stairway 2 meters wide and 10 meters long (along the incline). A single occupant with a maximum walking speed of 1.0 m/s begins at the base of the stairway and walks up to the exit. This example uses 7"x11" stairs.

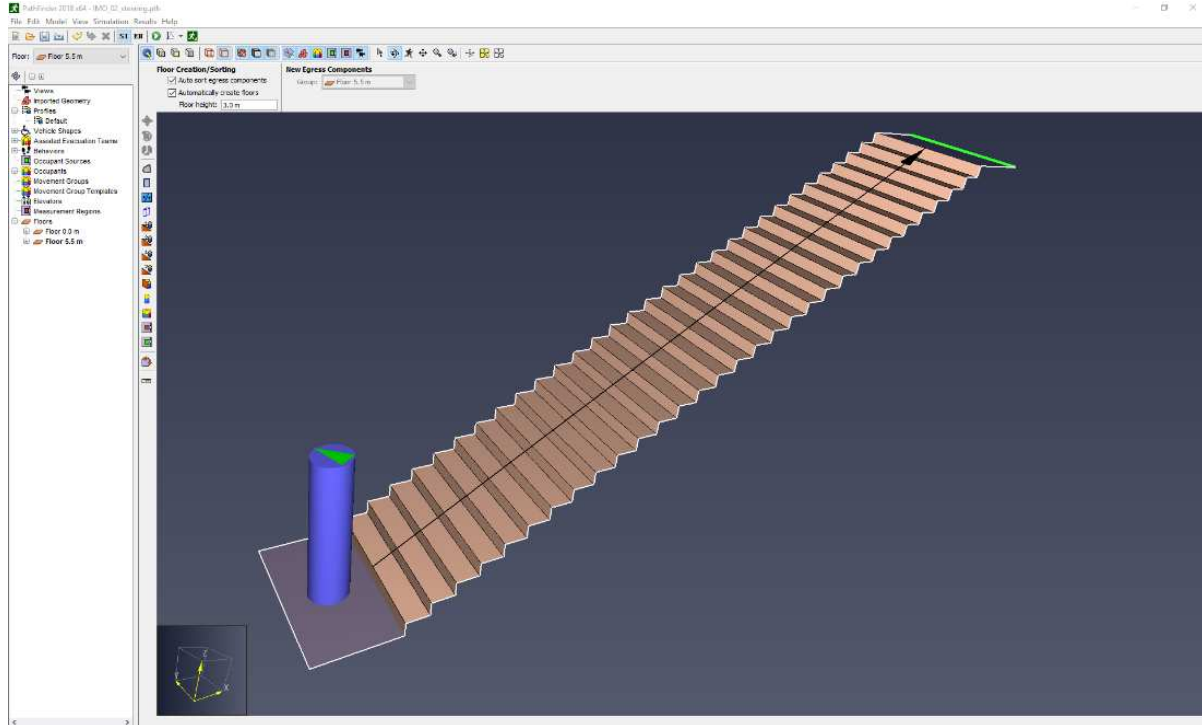

Figure 128. IMO_02 problem setup.

6.2.1. Setup Notes

The occupant was positioned on a lower landing at a distance 1.0 m from the staircase. For the steering mode this allows the occupant enough distance to accelerate to full speed before reaching the stairway. Pathfinder summary file reports the time of the first person entering a stairway and the time the last person leaves, so this provides an accurate measure of time on the stairs for a single occupant.

6.2.2. Expected Results

The occupant is given a base maximum speed of 1.0 m/s . The default Pathfinder assumption is to use the SFPE stair speed factors. This speed reduction will be used in all modes with the scaling factor based on the slope of the stairway. Using the velocity equations presented in the Pathfinder Technical Reference, this scale factor will be $(0.918\text{ m/s}) / (1.19\text{ m/s}) = 0.77$. This makes the effective stairway speed of the occupant $(1.0\text{ m/s}) * 0.77 = 0.77\text{ m/s}$. Based on this speed, the results for all modes should be the same at 12.99 s .

6.2.3. Results

Table 11 shows the time to ascend the staircase in each mode (i.e. the stair exit time minus the stair entry time).

Table 11. IMO_02 Results

Mode	Time
Steering	12.92
Steering + SFPE	13.02
SFPE	12.95

6.2.4. Analysis

All test results are within an acceptable margin of error.

6.3. Stairway Speed, Down (IMO_03)

This test case verifies movement speed down a stairway for a single occupant. The test case is based on *Test 3* given in Annex 3 of IMO 1533 (IMO 2016). The test case describes a stairway 2 meters wide and 10 meters long (along the incline). A single occupant with a maximum walking speed of 1.0 m/s begins at the top of the stairway and walks down to the exit. This example uses 7"x11" stairs.

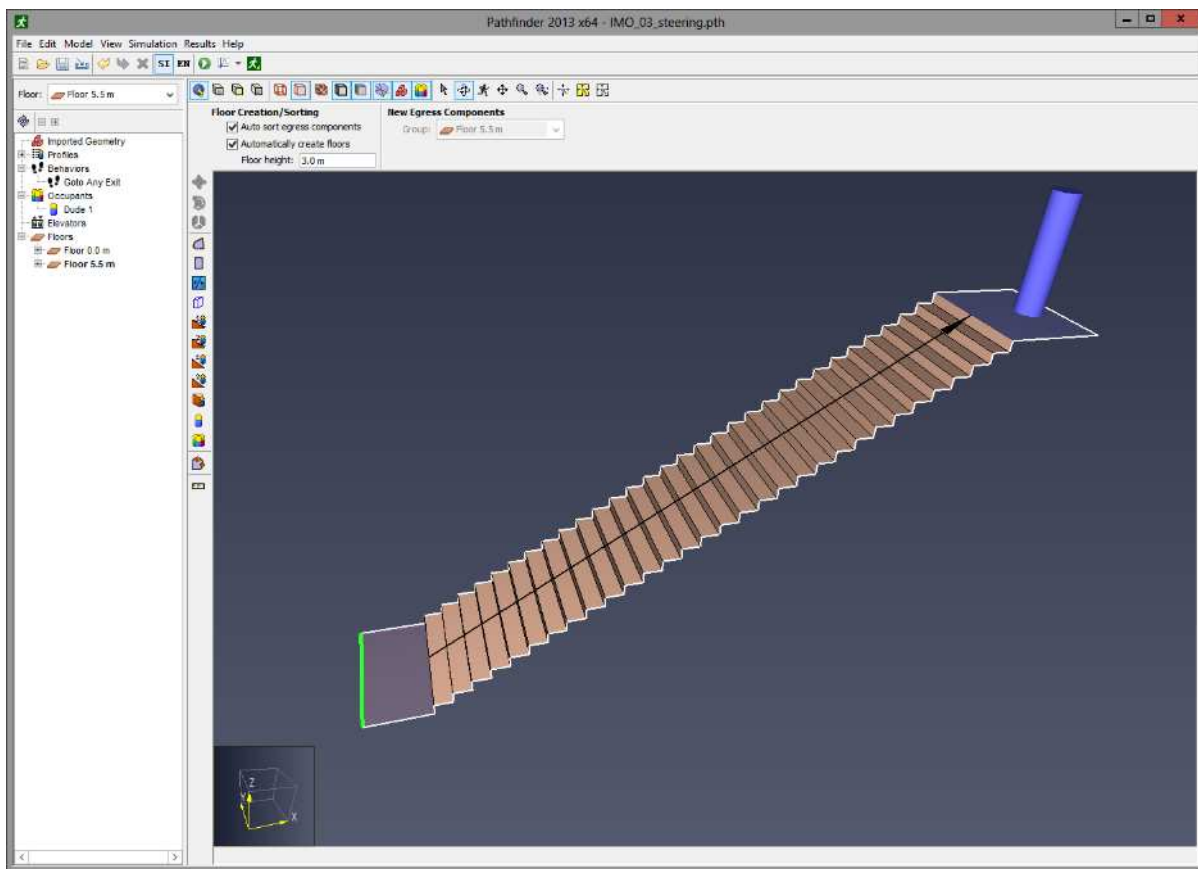

Figure 129. IMO_03 problem setup.

6.3.1. Setup Notes

The occupant was positioned on the upper landing at a distance 1.0 m from the staircase. For the steering mode this allows the occupant enough distance to accelerate to full speed before reaching the stairway. The length between the occupant's center starting position and the bottom of the staircase is slightly less than 10.0 m , since at the top of the stairs an occupant must allow for the door tolerance.

6.3.2. Expected Results

The occupant is given a base maximum speed of 1.0 m/s . The default Pathfinder assumption is to use the SFPE stair speed factors. This speed reduction will be used in all modes with the scaling factor based on the slope of the stairway. Using the velocity equations presented in the Pathfinder Technical Reference, this scale factor will be $(0.918\text{ m/s}) / (1.19\text{ m/s}) = 0.77$. This makes the effective stairway speed of the occupant $(1.0\text{ m/s}) * 0.77 = 0.77\text{ m/s}$. Based on this speed, the results for all modes should be the same at 12.99 s .

6.3.3. Results

Table 12 shows the time to descend the staircase in each tested mode (i.e. the stair exit time minus the stair entry time).

Table 12. IMO_03 Results

Mode	Time
Steering	12.92
Steering + SFPE	12.98
SFPE	12.94

6.3.4. Analysis

All test results are within an acceptable margin of error.

6.4. Door Flow Rates (IMO_04)

This case verifies the flow rate limits imposed by doorways in the SFPE modes. Results from the steering mode are included for comparison. The test case is based on *Test 4* given in Annex 3 of IMO 1533 (IMO 2016). The test case describes a room 8 meters by 5 meters with a 1 meter exit centered on the 5 meter wall. The room is populated by 100 occupants with the expectation that the average door flow rate over the entire period does not exceed 1.33 persons per second.

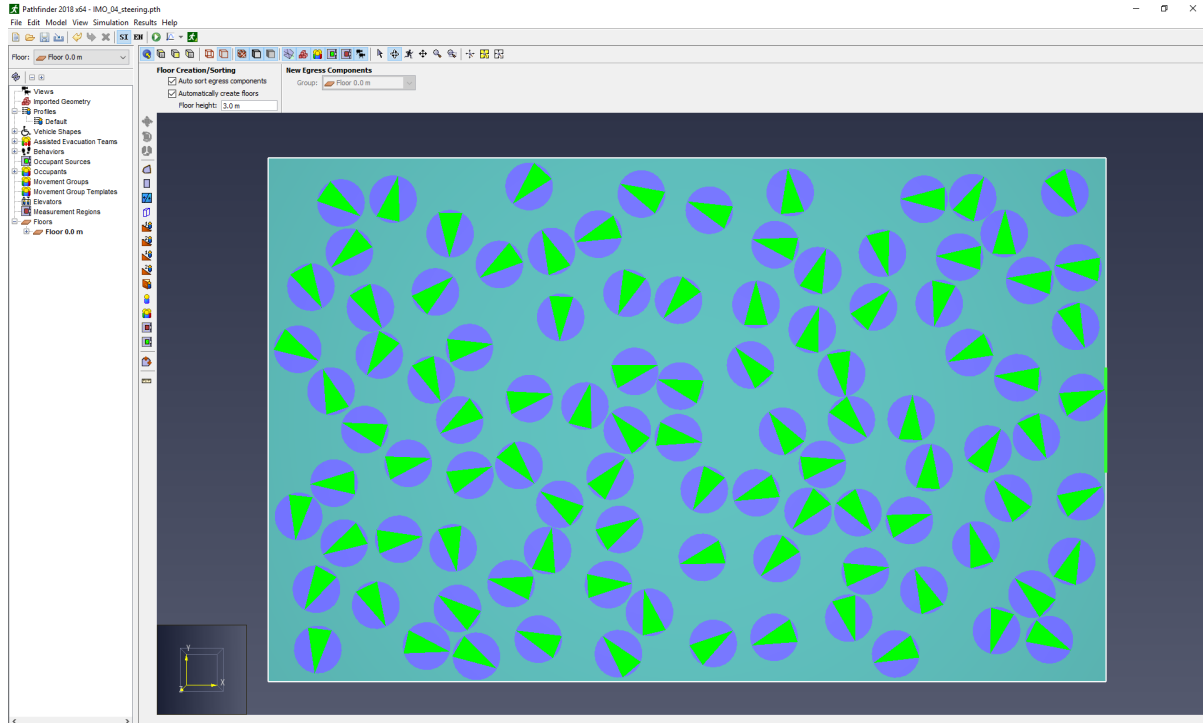

Figure 130. IMO_04 problem setup.

6.4.1. Setup Notes

Flow rate is measured using the simulation summary data. This average flow rate is defined as the number of occupants to pass through a door divided by the amount of time the door was "active." A door is considered to be active after the first occupant has reached the door and is no longer active when the last occupant has cleared the door.

Following SFPE guidelines, the boundary layer for all modes was 15 cm. With this boundary layer, the expected door flow rate for SFPE mode is 0.92 pers/s.

6.4.2. Expected Results

The maximum observed flow rate should be less than 1.33 persons per second.

6.4.3. Results

Table 13 shows the average exit door flow rates observed in each tested mode.

Table 13. IMO_04 Results

Mode	Time
Steering	1.04
Steering + SFPE	0.84

Mode	Time
SFPE	0.93

6.4.4. Analysis

The Steering+SFPE mode shows a slower exit door flow rate, due to the combination of steering movement and door flow rate limits. All test results are within an acceptable margin of error.

6.5. Initial Delay Time (IMO_05)

This case verifies initial delay (pre-movement) times. The test case is based on *Test 5* given in Annex 3 of IMO 1533 (IMO 2016). The test case describes a room 8 meters by 5 meters with a 1 meter exit centered on the 5 meter wall. The room is populated by 10 occupants with uniformly distributed response times ranging from 10 to 100 seconds. Figure 131 shows the initial problem setup. 10 occupants were added to the room at random locations.

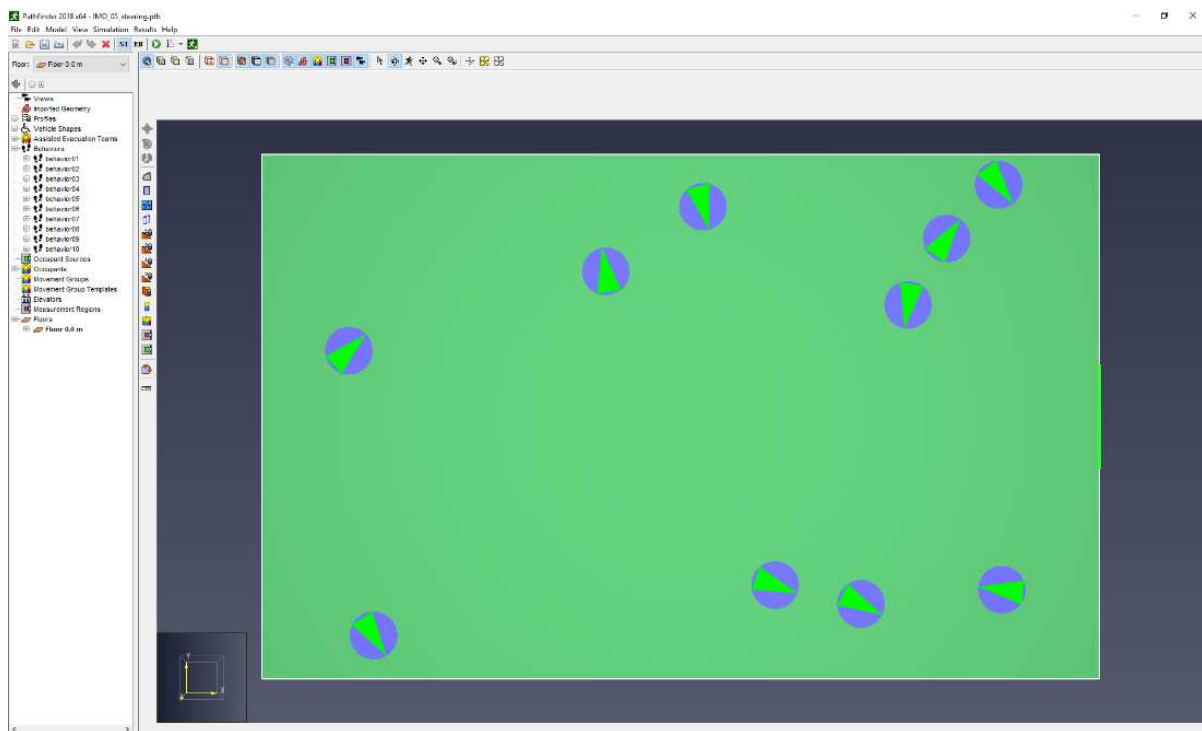

Figure 131. Problem setup for initial movement time verification.

6.5.1. Setup Notes

Occupants were assigned initial delays between a $\min = 10.0s$ and $\max = 100.0s$.

Occupant parameters were not randomized between simulations. This should lead to similar occupant count graphs.

6.5.2. Expected Results

Initial movement times should vary between occupants. This was verified by viewing the results animation. Pathfinder also has the option to output detailed comma-separated files for each occupant.

6.5.3. Results

Results for this problem were first verified using the animation. Results were also verified by examining the output in the detailed output data for each occupant.

6.5.4. Analysis

All simulator modes passed the test.

6.6. Rounding Corners (IMO_06)

The test case is based on *Test 6* given in Annex 3 of IMO 1533 (IMO 2016). The test case describes 20 occupants navigating a corner in a 2 meter wide corridor. The expected result is that the occupants round the corner without penetrating any model geometry.

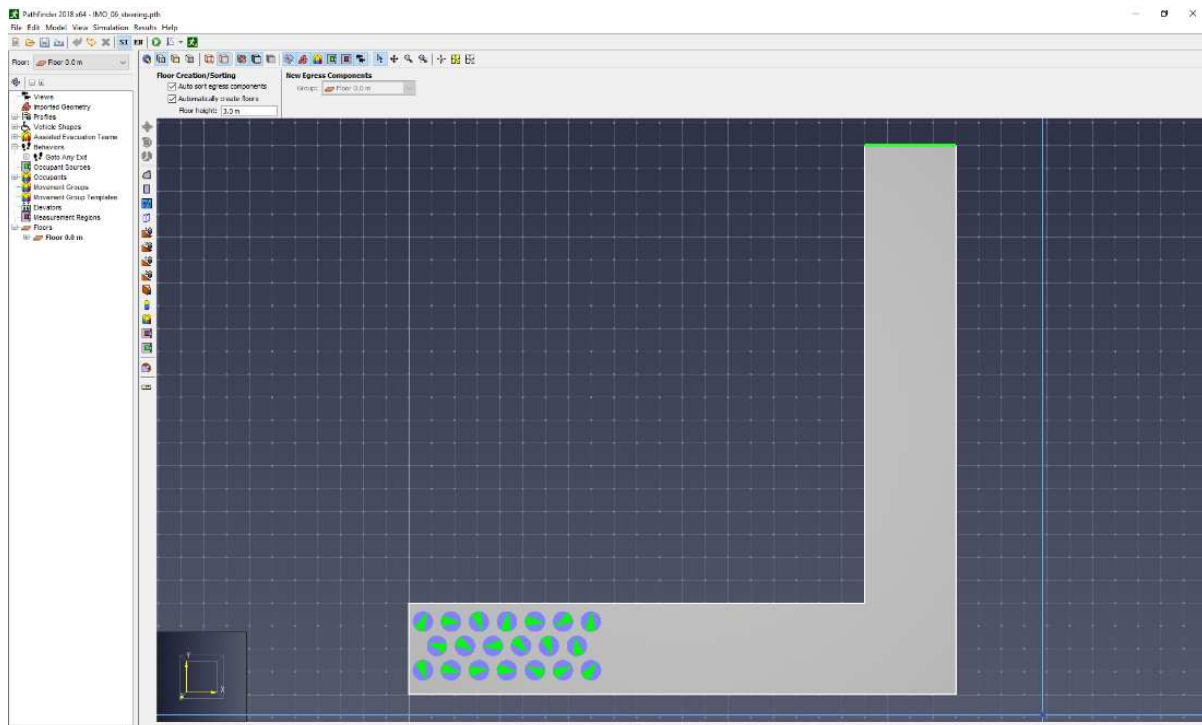

Figure 132. IMO_06 problem setup

6.6.1. Setup Notes

20 persons are uniformly distributed in the first 4 meters of the corridor.

6.6.2. Expected Results

Each occupant should navigate the model while staying inside the model boundaries. For the steering modes the occupants will retain a separation distance, but the SFPE mode allows multiple occupants to be located at the same space.

6.6.3. Results

Figure 133, Figure 134, and Figure 135 show the occupant trails for all 3 simulator modes. These movement trails can be used to verify that all occupants successfully navigated the corner.

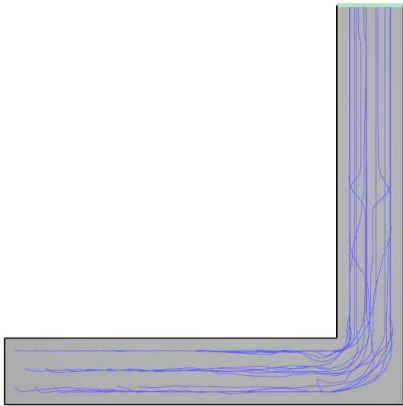

Figure 133. Occupant trails for boundary test:
Steering mode

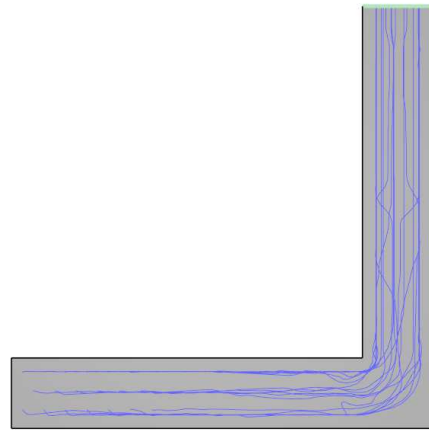

Figure 134. Occupant trails for boundary test:
Steering+SFPE mode

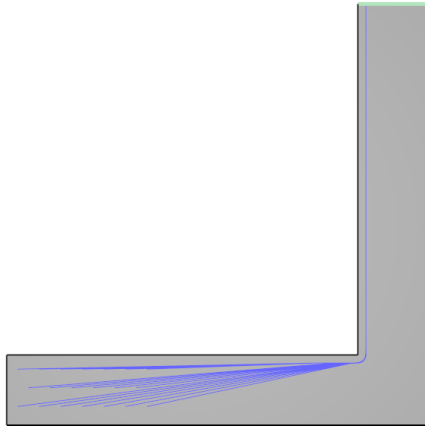

Figure 135. Occupant trails for boundary test: SFPE mode

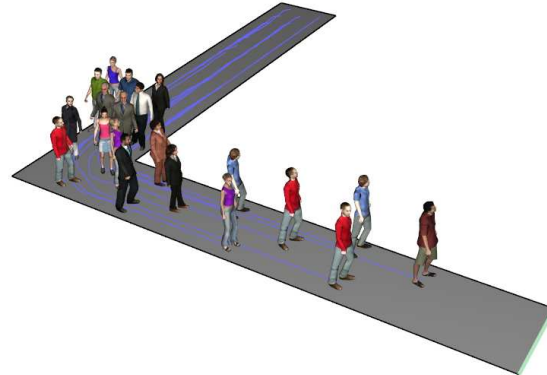

Figure 136. More realistic view of occupants for the steering mode analysis (at 15 seconds)

6.6.4. Analysis

Occupant trails indicate that no occupants passed outside the simulation boundary in any of the three simulation modes. All simulation modes successfully pass the verification test. The SFPE mode is basically a flow calculation, so occupants may be superimposed in the same space. The steering mode provides the most realistic movement.

All simulator modes passed the test.

6.7. Multiple Movement Speeds (IMO_07)

This test verifies multiple walking speeds in Pathfinder. The test case is based on *Test 7* given in Annex 3 of IMO 1533 (IMO 2016). The test case involves the assignment of population demographics to a group of occupants.

6.7.1. Setup Notes

A walking speed profile representing males 30-50 years old is distributed across 50 occupants. The walking speeds are a uniform random distribution with a minimum of 0.97 m/s and a maximum of 1.62 m/s. The information for this profile comes from Table 3.4 in the appendix to the Interim Guidelines for the advanced evacuation analysis of new and existing ships.

The occupants were positioned in a line 0.5 m from the left side of a 40.5×51.0 m room. The exit door is on the opposite side of the room. Each occupant moves with their assigned speed in a straight line to the right.

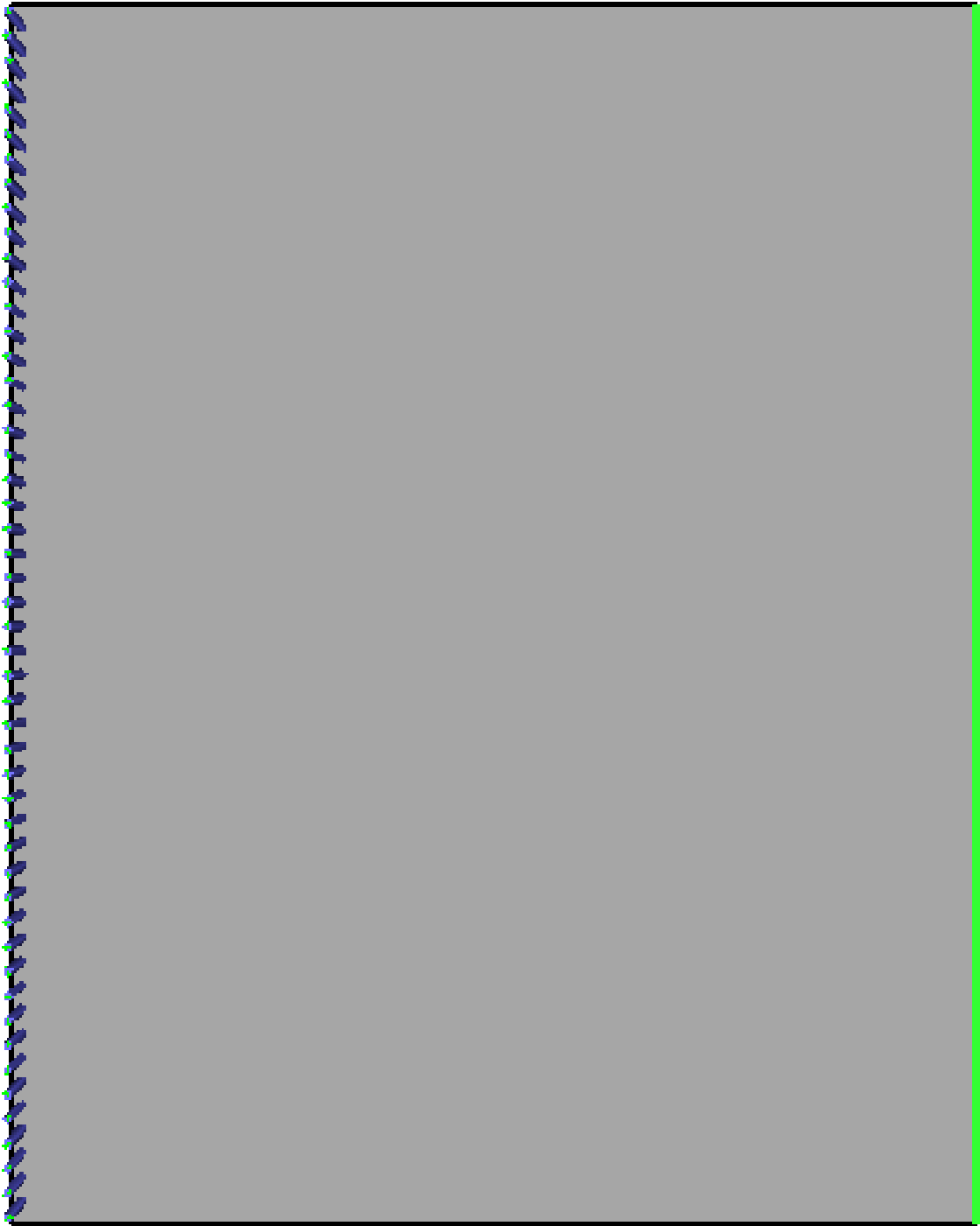

Figure 137. IMO_07 problem setup

6.7.2. Expected Results

The occupants should display a range of walking speeds within the specified limits, so that the arrival times at the right edge of the room should be between 24.7 s and 41.2 s (neglecting the

inertia in the steering mode).

6.7.3. Results

The occupants' speeds observed in the simulation were within the specified limits. The first arrival and last arrival times at the exit are given in the table below. [Figure 138](#) shows the occupant paths at 20 s for steering mode (other cases are similar).

Table 14. Table showing first and last arrival times across all three modes.

Mode	First Arrival (s)	Last Arrival (s)
Steering	25.35	41.92
Steering + SFPE	25.35	41.92
SFPE	24.82	40.95

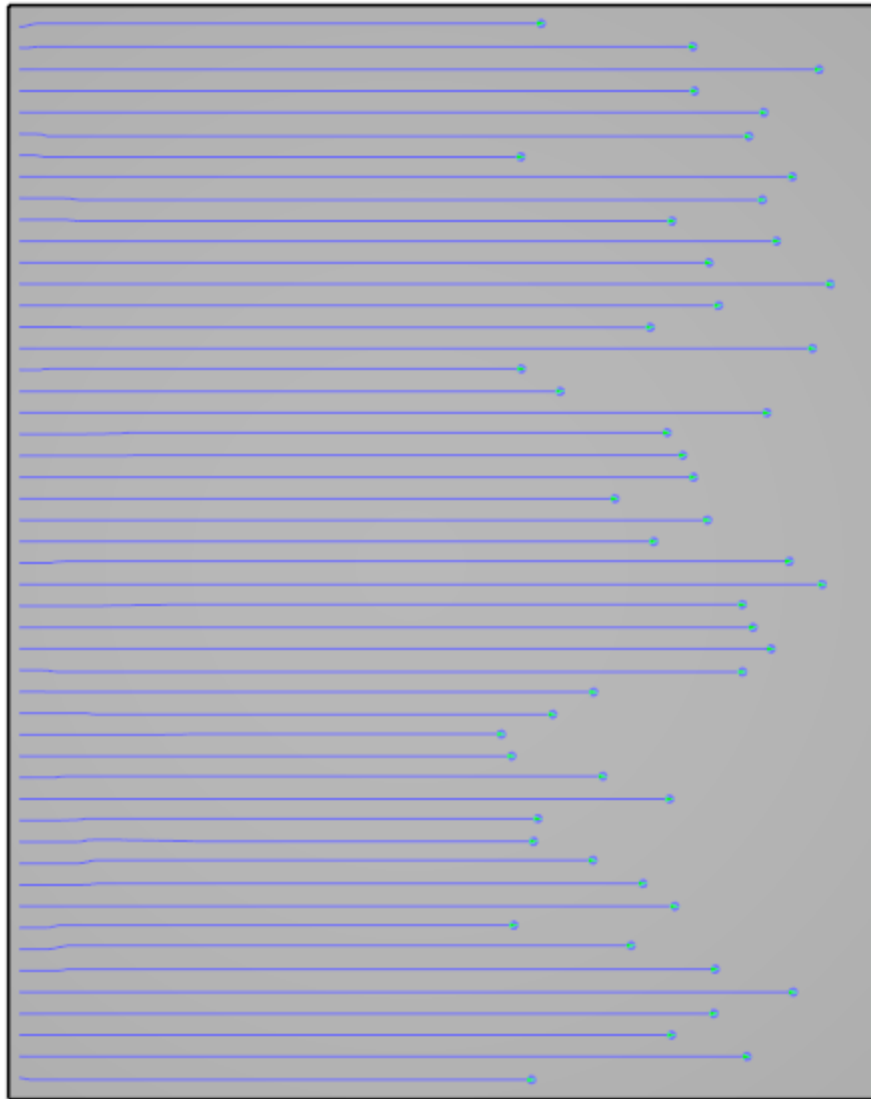

Figure 138. IMO_07 results showing occupant paths at 20 s

6.7.4. Analysis

All simulator modes passed.

6.8. Counterflow (IMO_08)

This test verifies Pathfinder's counterflow capability. The test case is based on *Test 8* given in Annex 3 of IMO 1533 (IMO 2016). The test case involves the interaction of occupants in counterflow. Two 10 meter square rooms are connected in the center by a 10 meter long, 2 meter wide hallway. 100 persons are distributed on the far side of one room as densely as possible, and

move through the corridor to the other room. Occupants in the other room move in the opposite direction. The test is run with 0, 10, 50, and 100 occupants moving in counterflow with the original group.

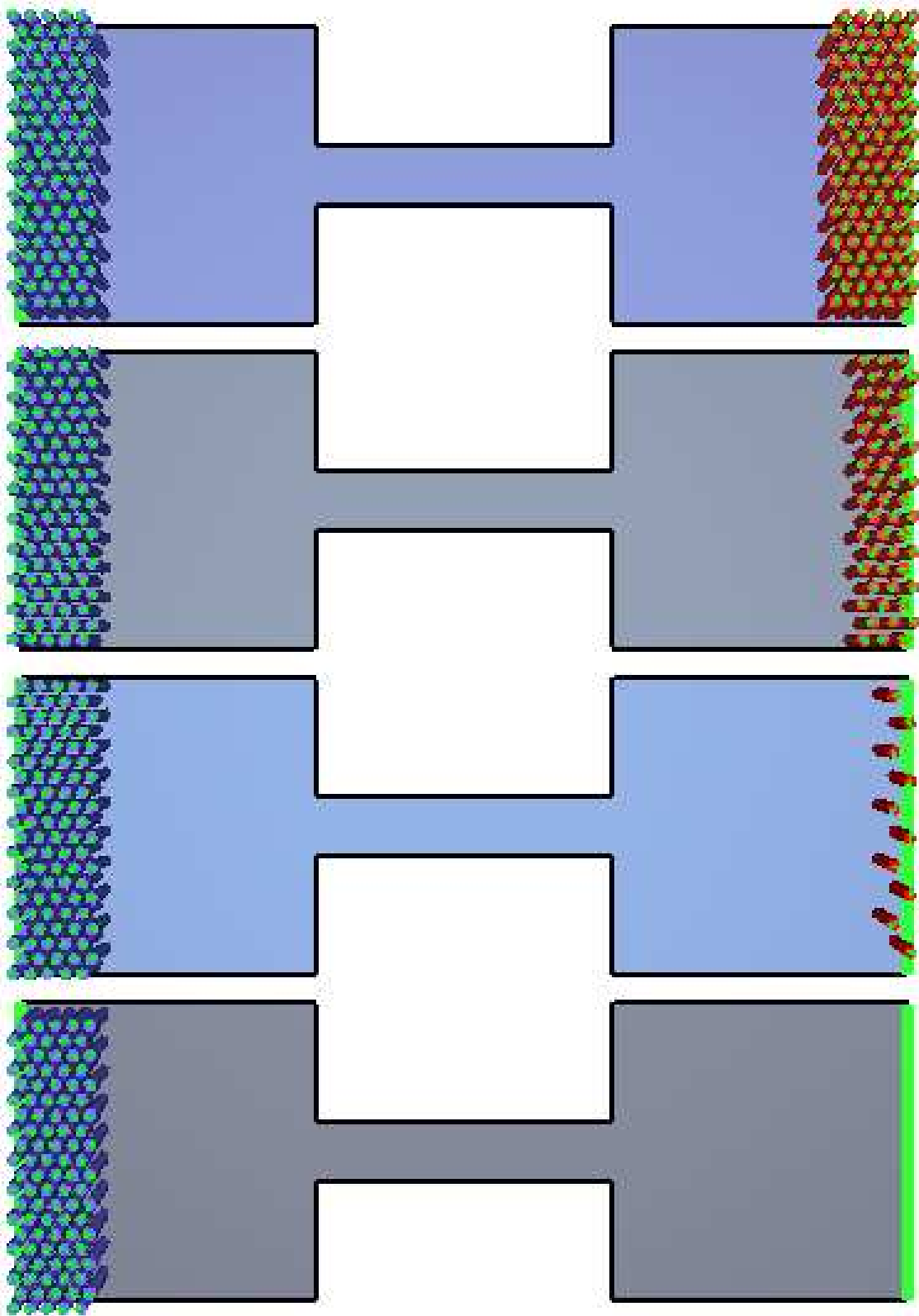

Figure 139. IMO_08 problem setup containing all four configurations and doors in the corridor

entrances

6.8.1. Setup Notes

The problem geometry is set up as described above, with exits at the far walls. The occupants in each room are assigned the exit in the opposite room.

To simplify collection of results, all four simulation scenarios are created in the same model. This can be accomplished by duplicating the initial geometry 3 times, then using different numbers of occupants in the room at the right.

A walking speed profile representing males 30-50 years old is distributed across all occupants. The walking speeds are a uniform random distribution with a minimum of 0.97 m/s and a maximum of 1.62 m/s . The information for this profile comes from Table 3.4 in the appendix to the Interim Guidelines for the advanced evacuation analysis of new and existing ships.

6.8.2. Expected Results

As the number of occupants in counterflow increases, the occupants should slow down and increase the evacuation time.

Since in the SFPE mode, there is no restriction on occupants being superimposed in the same space, counterflow does not slow the movement (room density does reduce walking speed for this case).

6.8.3. Results

Figure 140 shows the occupant positions for the steering mode, 100 person counterflow case at 75 s.

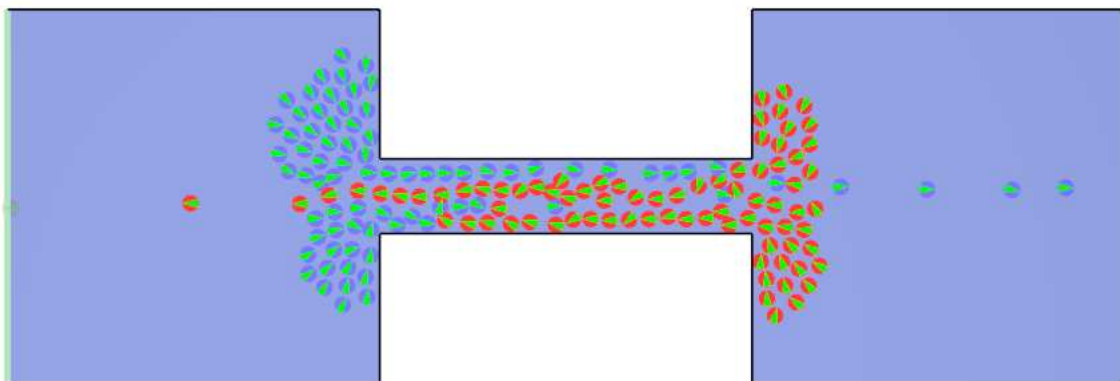

Figure 140. Occupant positions for the steering mode, 100 person counterflow case at 75 s

Table 15 shows the time it takes occupants that start on the left to exit the simulation on the right. The times are given as a function of the number of occupants in counterflow.

Table 15. Table Showing Occupant Exit Times

	Number of Occupants Starting on Right Side			
	0	10	50	100
Mode	Exit Time Right (s)			
Steering	67.65	78.78	143.07	220.53
Steering + SFPE	67.65	78.78	143.07	220.53
SFPE	29.95	30.68	31.45	33.2

6.8.4. Analysis

In each mode, more counterflow increases evacuation time. The SFPE mode does not account for counterflow interference, the increased times are due to increased room density slowing the speed.

See [Section 2.2](#) for a comparison with experimental data for bidirectional flow.

All modes passed test criteria.

6.9. Sensitivity to Available Doors (IMO_09)

This test verifies Pathfinder's exit time sensitivity to a changing number of available doors. The test case is based on *Test 9* given in Annex 3 of IMO 1533 ([IMO 2016](#)). The test case involves the evacuation of 1000 occupants from a large room, 30 meters by 20 meters, with doors of 1.0 m width. The 1000 occupants are distributed uniformly in the center of the room, 2 meters from each wall. The test is run with 4 exits and 2 exits, with the expectation that the evacuation time will double in the 2 exit case.

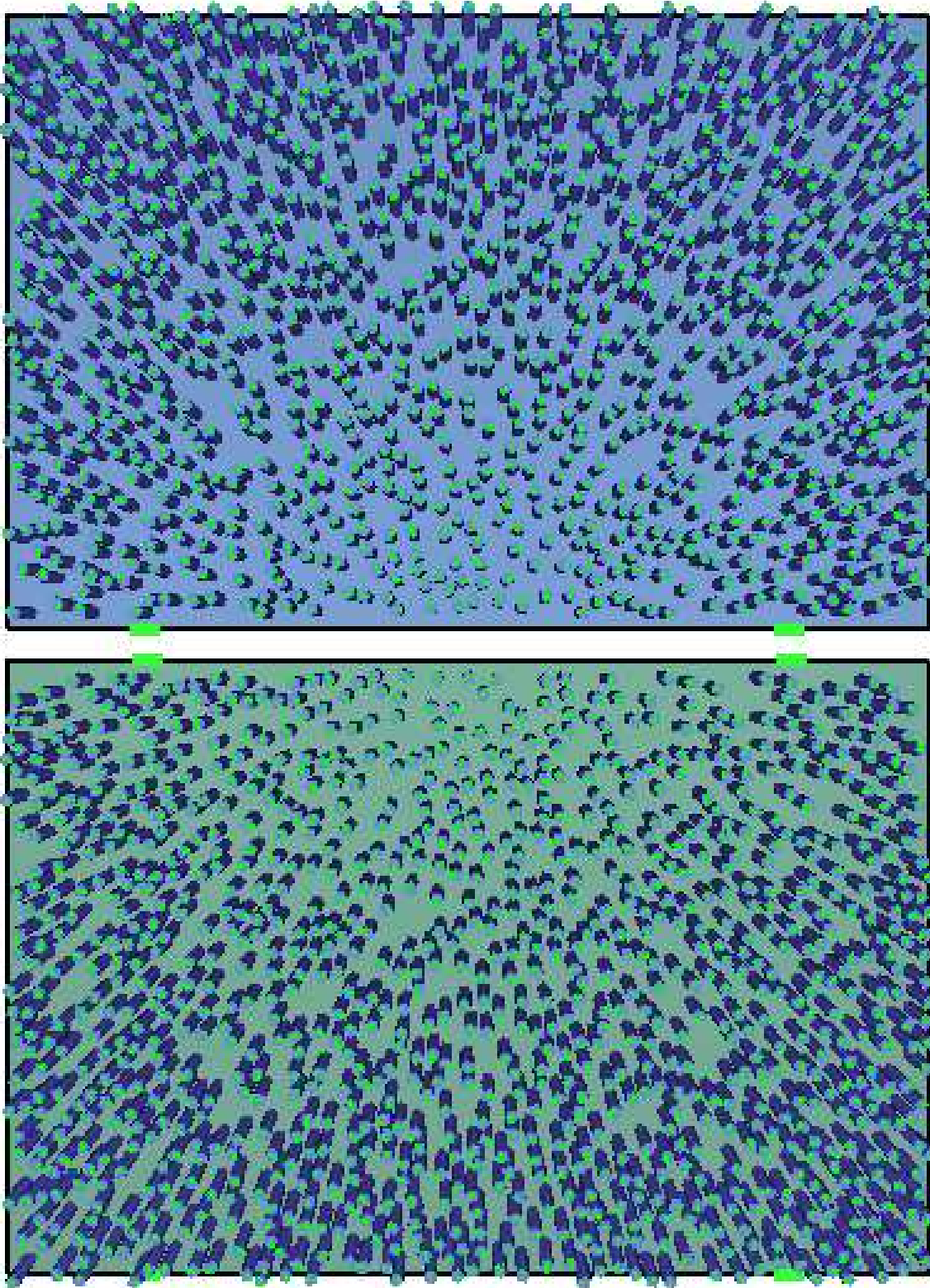

Figure 141. IMO_09 problem setup containing both configurations

6.9.1. Setup Notes

Occupants are given a profile corresponding to males 30-50 years old from Table 3.4 in the appendix to IMO 1238 (IMO 2016). The walking speeds are a uniform random distribution with a minimum of 0.97 m/s and a maximum of 1.62 m/s.

To simplify data collection, both model configurations are added to a single simulation model.

6.9.2. Expected Results

Simulation time should approximately double when using half as many doors.

For the SFPE mode, the expected single door flow rate is 0.924 pers/s (15 cm boundary included), giving an evacuation time of 541 s for two doors and 271 s for four doors.

6.9.3. Results

Table 16 shows the time it takes to exit the simulation for both cases. Since the initial locations of the occupants were randomly assigned, the number of persons that exit each door are not exactly equal.

Table 16. Table Showing Exit Times for All 3 Modes.

Model	4 Doors		2 Doors	
	Min (s)	Max (s)	Min (s)	Max (s)
Steering	203.18	211.43	409.90	413.30
Steering + SFPE	283.04	295.06	578.17	582.51
SFPE	264.77	275.60	540.68	549.33

6.9.4. Analysis

For all modes, the simulation times, while not exactly double, are well within the acceptable margin for validity.

All modes passed test criteria.

6.10. Exit Assignments (IMO_10)

This test verifies exit assignments in Pathfinder. The test case is based on *Test 10* given in Annex 3 of IMO 1533 (IMO 2016). 23 occupants are placed in a series of rooms representing ship cabins and assigned specific exits.

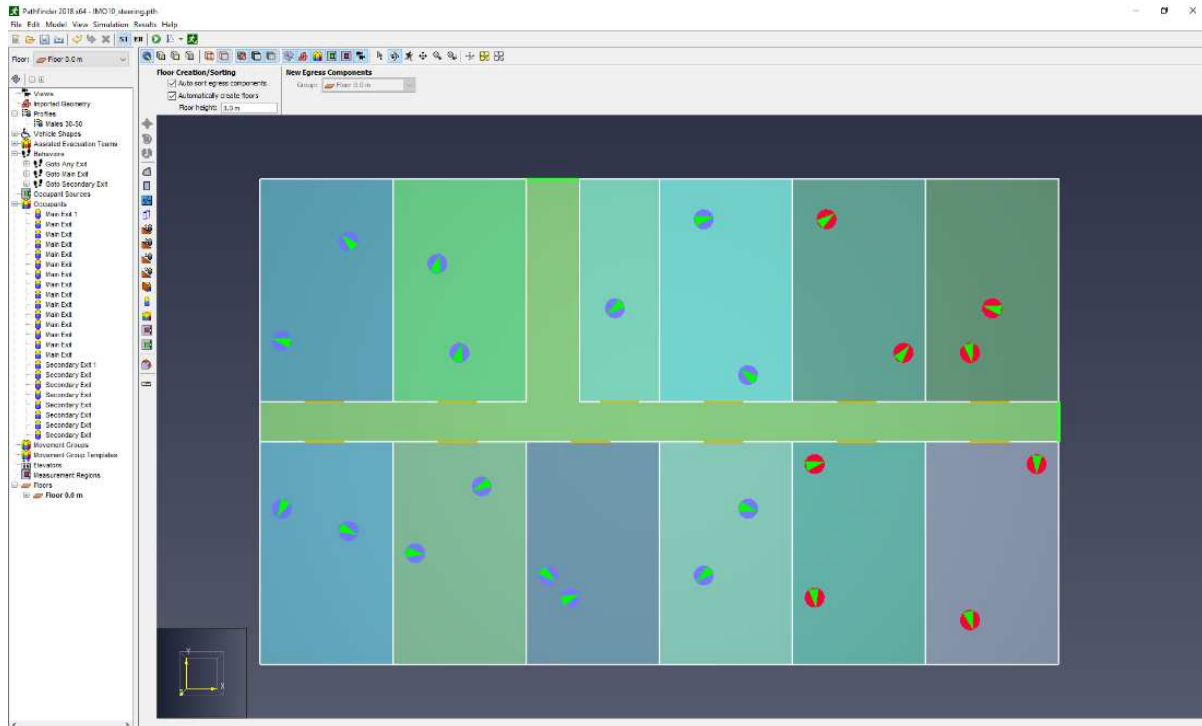

Figure 142. IMO_10 problem setup

6.10.1. Setup Notes

The occupants in the left 8 rooms are assigned to the main (top) exit. The occupants in the remaining 4 rooms are assigned to the secondary (right) exit. Occupants are given a profile corresponding to males 30-50 years old from Table 3.4 in the appendix to IMO 1238 (IMO 2016). The walking speeds are a uniform random distribution with a minimum of 0.97 m/s and a maximum of 1.62 m/s.

6.10.2. Expected Results

Each occupant should leave the model using the specified exit.

6.10.3. Results

Figure 143 shows the paths taken by occupants in steering mode (other modes were similar). The trails of the four occupants intended to use the secondary exit are shown in red, all other occupant trails are shown in blue.

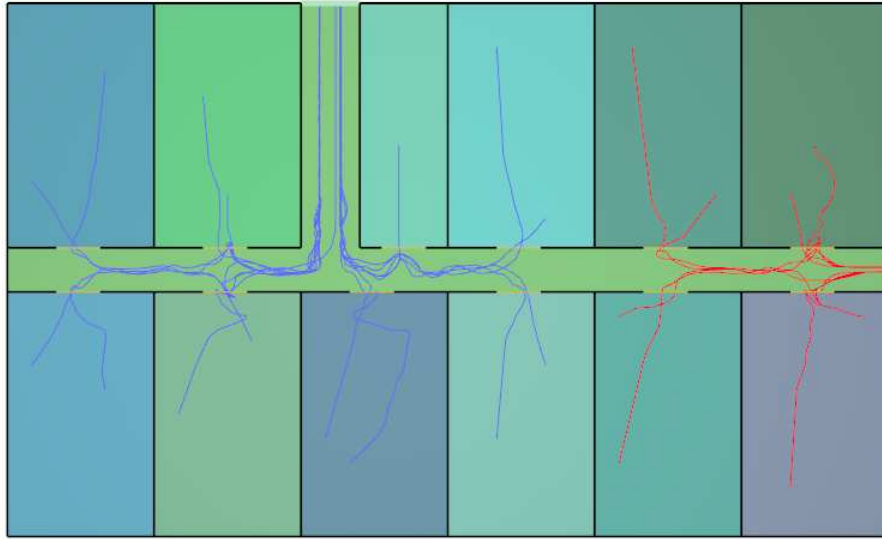

Figure 143. Trace of occupant paths in steering mode

6.10.4. Analysis

The results for all simulator modes indicate that the four occupants directed to exit via the secondary exit, did so.

All modes passed test criteria.

6.11. Congestion (IMO_11)

This test examines the formation of congestion in Pathfinder. The test case is based on *Test 11* given in Annex 3 of IMO 1533 (IMO 2016). 150 occupants must move from a 5 m x 8 m room, to a 2 m x 12 m corridor, up a stairway, and out of the simulation via a 2 m wide platform. Congestion is expected to form initially at the entrance to the corridor, then later at the base of the stairs.

Figure 144 shows the problem setup in Pathfinder. The red rectangle indicates the region used to measure density.

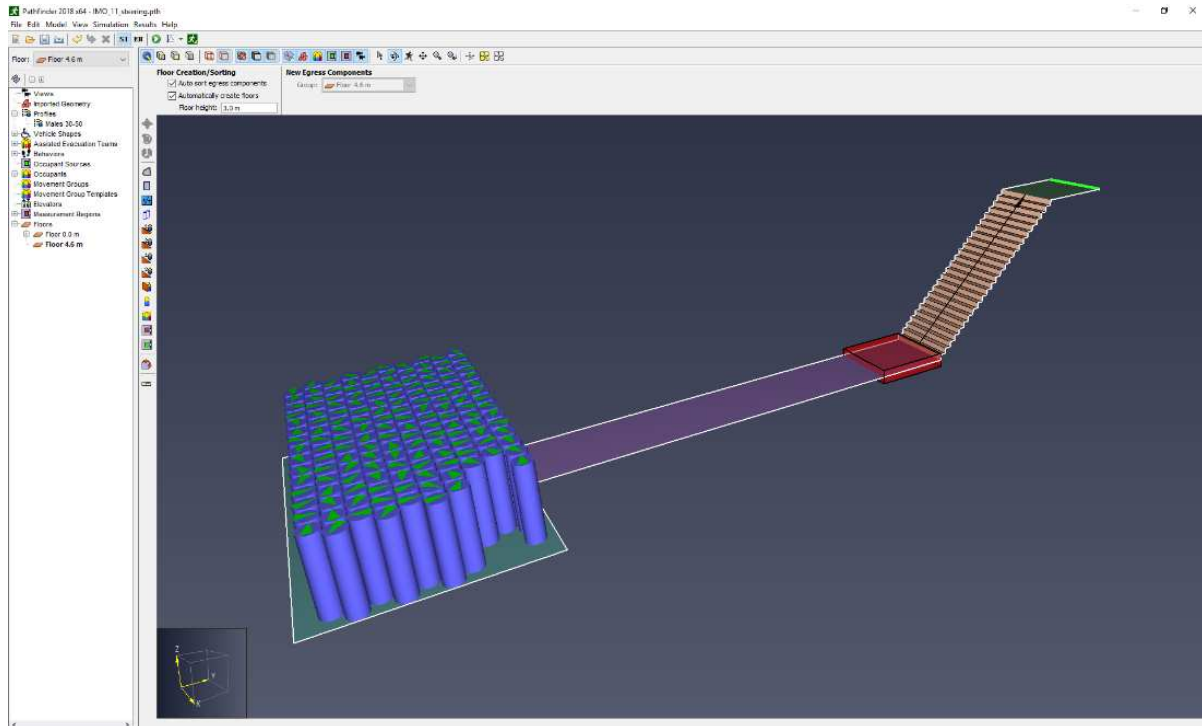

Figure 144. IMO_11 problem setup.

A specific definition for congestion is given in Section 3.7 of IMO 1533 (IMO 2016). Congestion is present when either of the following conditions is achieved: initial density is at least 3.5 pers/m^2 , or queues grow (occupants accumulate) at a rate of more than 1.5 pers/s at a joint between two egress components.

The initial density in the $5\text{m} \times 8\text{m}$ room containing 150 occupants is 3.75 pers/m^2 . Based on the congestion criteria, this condition is sufficient to qualify the initial room as congested.

Congestion is measured using the queue at the base of the stairway. Congestion is identified by either of the following criteria: (1) initial density equal to, or greater than, 3.5 persons/m^2 ; or (2) significant queues (accumulation of more than 1.5 persons per second between ingress and exit from a point).

6.11.1. Setup Notes

The 150 occupants are added to the initial room using a uniform distribution.

All occupants were assigned a profile corresponding to 30-50 year old males (as specified in Table 3.4, International Maritime Organization, 2016). On level terrain (corridor), this gives a uniform speed distribution ranging from 0.97 m/s to 1.62 m/s (mean 1.3 m/s). Table 1.1 of the IMO report gives the speed-density curve to be used in calculations. For a corridor, at a density of 0.5 pers/m^2 the speed is 1.2 m/s and at a density of 3.5 pers/m^2 the speed is 0.1 m/s . The corresponding normalized speed-density profile is shown in Figure 145.

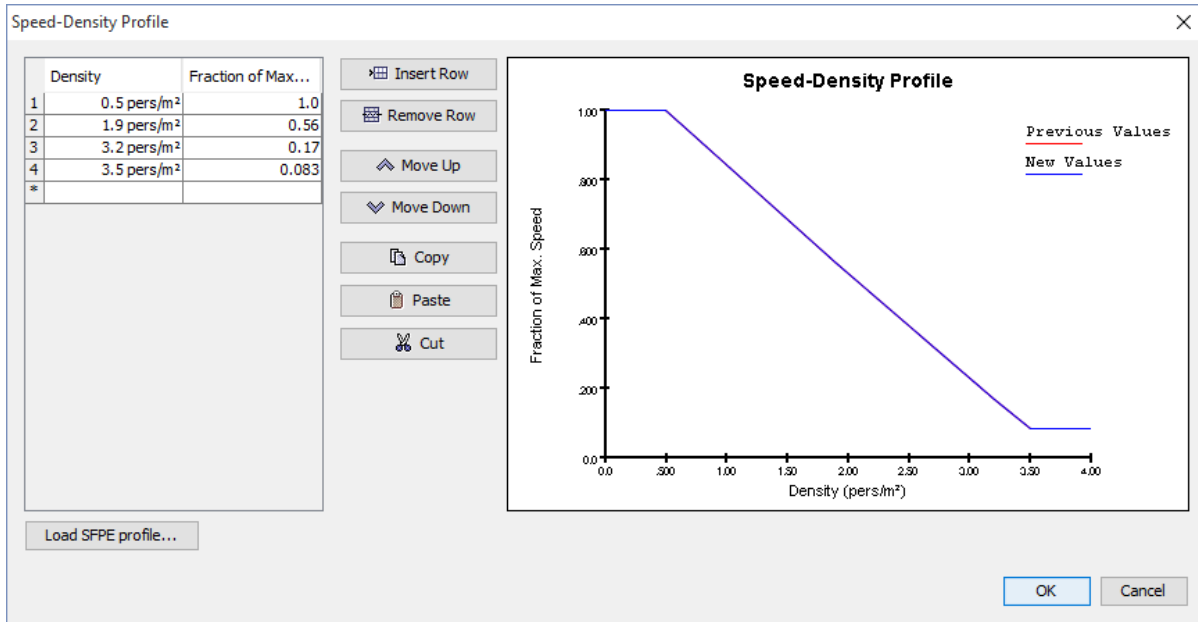

Figure 145. Normalized speed-density profile for 30-50 year old males on level corridor.

When walking up on stairs, the speed is a uniform speed distribution ranging from 0.47 m/s to 0.79 m/s (mean 0.63). Table 1.3 of the IMO report gives specific flow and speed curves to be used on stairs up. At a density of 0.5375 pers/m² the speed is 0.8 m/s and at a density of 2 pers/m² the speed is 0.44 m/s. The corresponding normalized speed-density profile on stairs up is shown in normalized-speed-density.

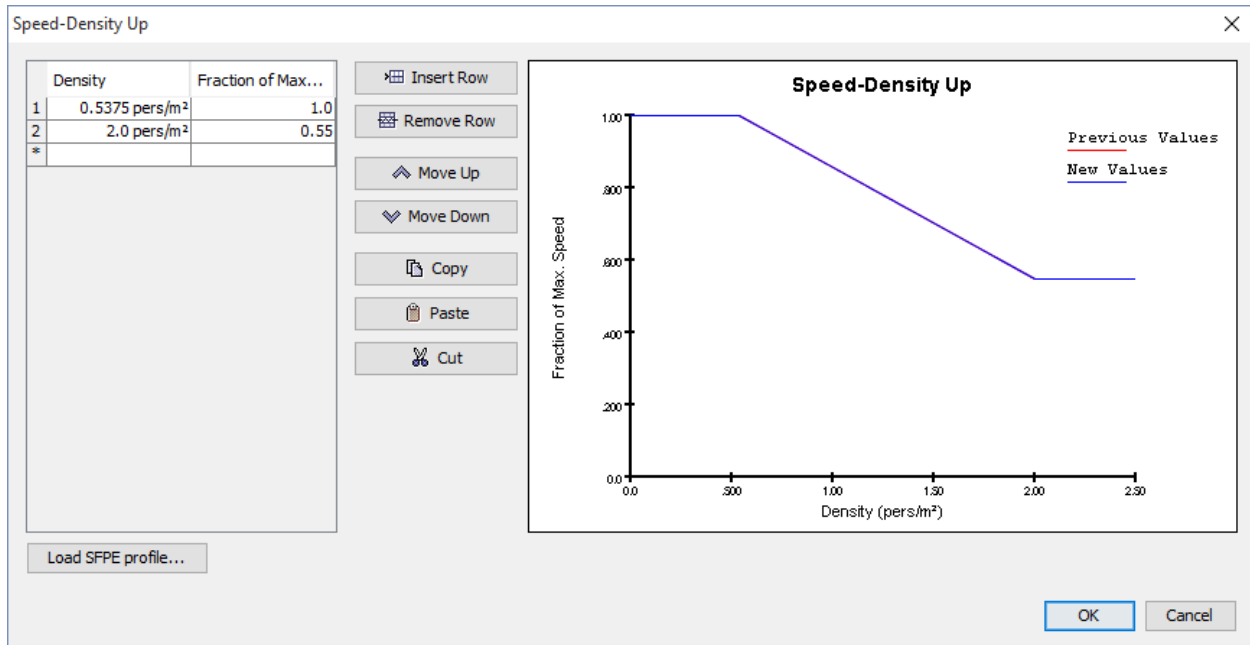

Figure 146. Normalized speed-density profile for 30-50 year old males on stairs up.

6.11.2. Expected Results

Congestion should form in the corridor leading to the stairs. This will be measured by the mean density and mean velocity of the occupants in a 2x2 m rectangle at the base of the stairs. The results with and without stairs will be compared.

We can estimate the fastest exit time for the SFPE case. For a walking speed of 1.62 m/s, the time to cross the 12 m corridor is 7.4 s (neglecting inertia). The length of the stairs is 5.7 m, so for a 50% speed decrease on stairs, the time required is 7.0 s. Crossing the landing requires another 1.2 s, for a total of time of 15.6 s.

6.11.3. Results

The total evacuation times for the three cases are given in [Table 17](#).

Table 17. Total Evacuation Time for All Three Modes

Mode	First Out (s)	Last Out (s)
Steering	17.00	153.70
Steering + SFPE	17.48	156.70
SFPE	17.90	160.90

[Figure 147](#) visually shows congestion forming at the base of the stairs. The density contour shows densities of about 2.75 pers/m² at the base of the stairs.

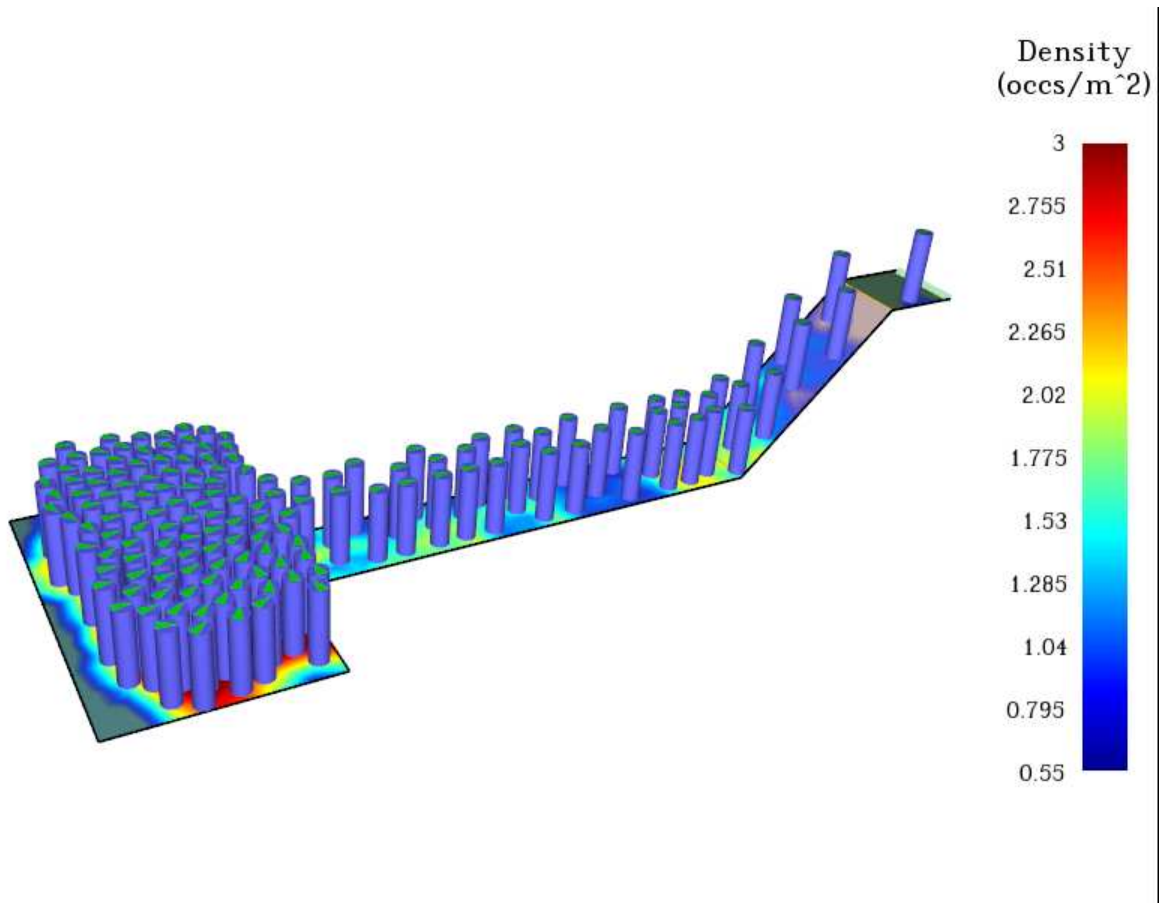

Figure 147. Visual demonstration of congestion at base of stairs.

Time history data describing the mean density and walking speeds for the occupants at the base of stairs with and without stairs are shown in [Figure 148](#) and [Figure 149](#). Without stairs, the occupants continue moving to the exit with a speed of about 1 m/s and the maximum density is about 1.25 pers/m². With stairs, congestion forms leading to a maximum density of about 3.0 pers/m² and the speed drops to about 0.25 m/s.

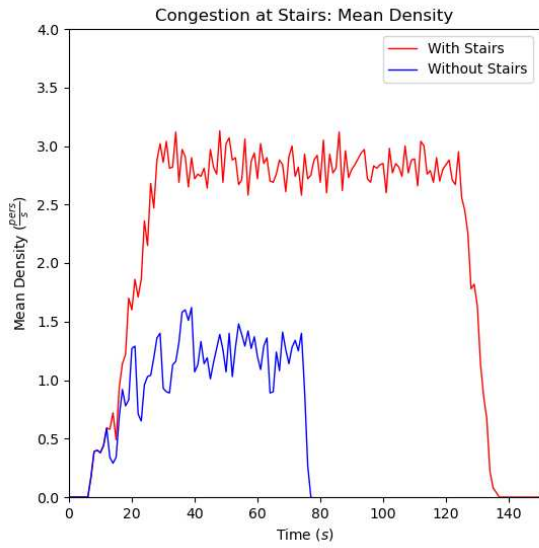

Figure 148. Comparison of mean density at base of stairs with and without stairs.

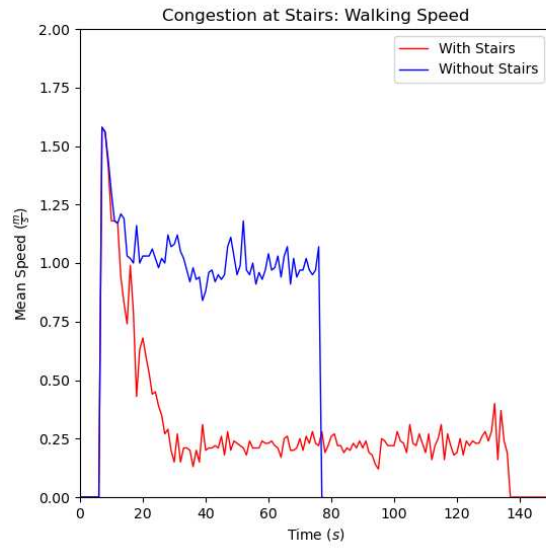

Figure 149. Comparison of walking speeds at base of stairs with and without stairs.

6.11.4. Analysis

Congestion forms at the base of the stairs as shown by comparing the mean density and speeds at the base of the stairs for cases with and without stairs. Because of the assumed fundamental diagram, the maximum density reaches approximately 3.0 pers/m², not the 3.5 pers/m² assumed in HMO for congestion.

However, the Pathfinder results show congestion that is consistent with the specified walking speeds and speed-density curves.

Chapter 7. NIST Evacuation Tests

This section presents test cases described in NIST Technical Note 1822 (2013). Section 3 (Suggested Verification and Validation Tests) presents a new set of recommended verification tests and discusses possible examples of validation tests. Tests have been presented in relation to the five main core elements available in evacuation models, namely 1) pre-evacuation time, 2) movement and navigation, 3) exit usage, 4) route availability and 5) flow conditions/constraints.

7.1. Pre-evacuation time distributions (Verif.1.1)

A modification of IMO Test 5, which has already been presented.

7.2. Speed in a corridor (Verif.2.1)

IMO Test 1, which has already been presented.

7.3. Speed on stairs (Verif.2.2)

IMO Tests 2 and 3, which have already been presented.

7.4. Movement around a corner (Verif.2.3)

IMO Test 6, which has already been presented.

7.5. Assigned demographics (Verif.2.4)

A modification of IMO Test 7, which has already been presented.

7.6. Reduced visibility vs walking speed (Verif.2.5)

The current version of Pathfinder does not use visibility to change walking speeds, so this verification test is not applicable.

Pathfinder does allow the user to specify a Speed Modifier by room that can be defined as values as a function of time. This can be used to approximate the effect of smoke in a room. See [Manually Coupling FDS and Pathfinder to Respond to Smoke](#).

7.7. Occupant incapacitation (Verif.2.6)

This test verifies the capability to simulate occupant incapacitation due to the toxic and physical effects of smoke. Pathfinder can calculate FED for occupants, but the FED exposure does not

change the behavior of the occupants.

The suggested test, [Figure 150](#), is a room with no fire source (10 m x 10 m x 3m). A stationary occupant is positioned in the room. The room is filled with gas at hazardous conditions consistent with the Fractional Effective Dose (FED) calculation implemented in the software. Comparisons are made with hand calculations or fire model simulation.

[Figure 151](#) shows the Pathfinder model. At the center of the model, devices are used to measure [stem f74275c195a72099e0b06f584fd5489a], [stem 8306272097a2ac71e3c568c80d48b7f9], [stem adae461c37eccd2f2a6ed21ebf2c5d08], and the FED value calculated by FDS.

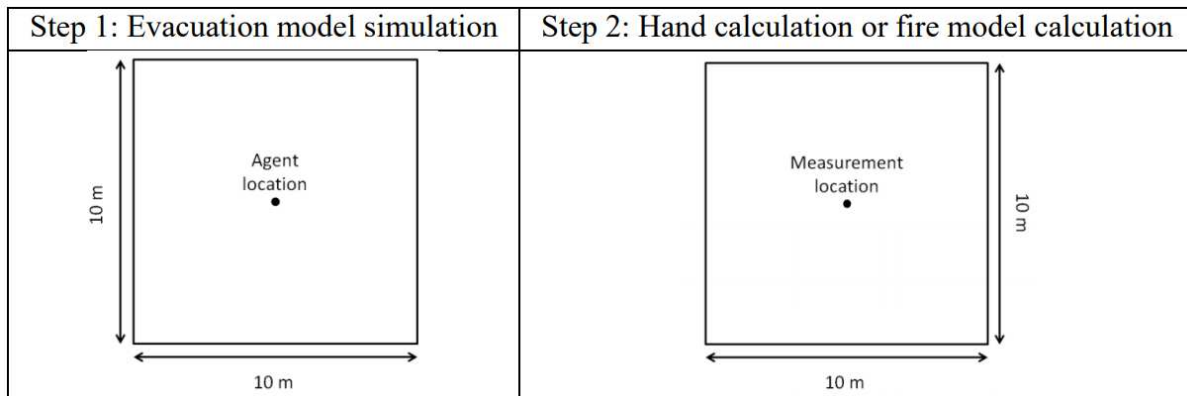

Figure 150. Geometry of incapacitation verification (Verif.2.6). Figure from NIST Technical Note 1822, 2013.

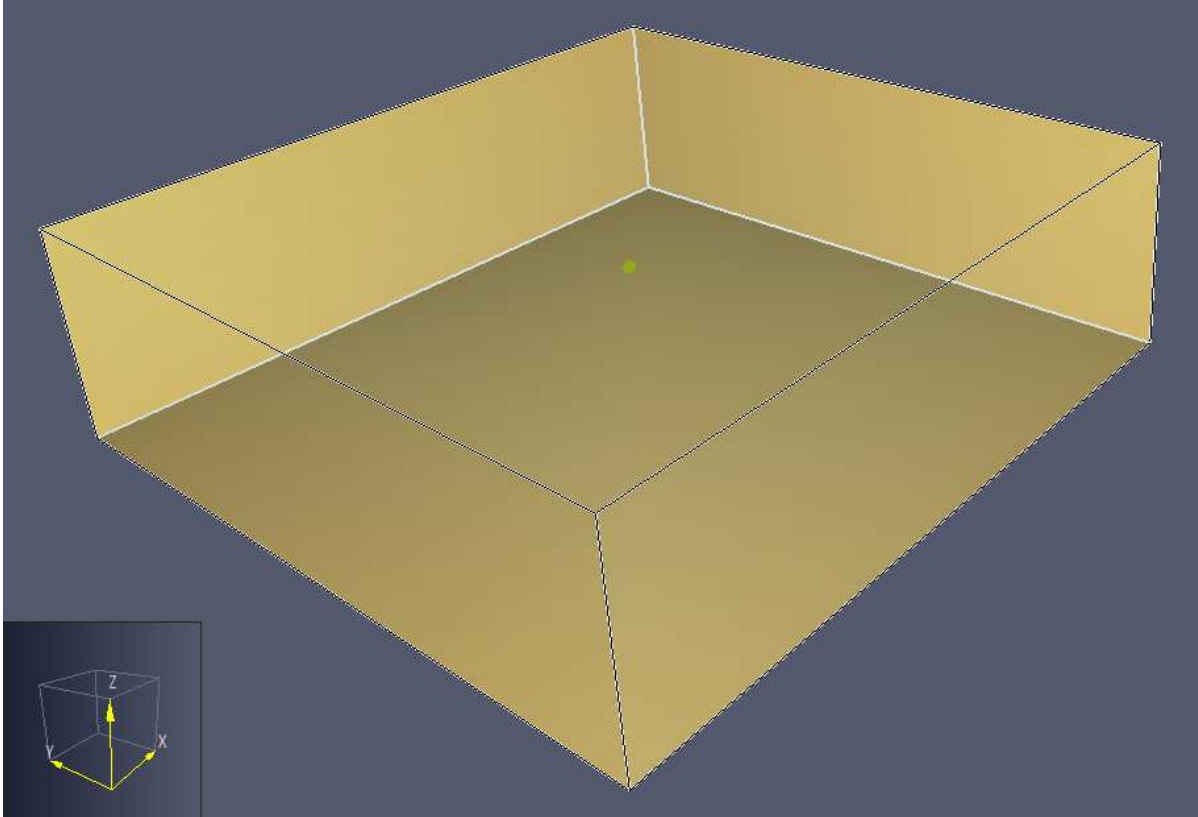

Figure 151. Pathfinder model

7.7.1. Setup Notes

The Pathfinder calculation of Fractional Effective Dose (FED) uses the equations described in the SFPE Handbook of Fire Protection Engineering (5th Edition, Vol 3, Chapter 63, pages 2308-2428). The implementation uses only the concentrations of the narcotic gases [stem f74275c195a72099e0b06f584fd5489a], [stem 8306272097a2ac71e3c568c80d48b7f9], and [stem adae461c37eccd2f2a6ed21ebf2c5d08] to calculate the **FED** value.

$$[\$FED_{tot} = FED_{CO} \times VCO_2 + FED_{O_2}] | ../../../../includes/images/stem-$$

62bc89c080a89ef6aee478a3c6265cdc.png

This calculation does not include the effect of hydrogen cyanide (HCN) and the effect of [stem 8306272097a2ac71e3c568c80d48b7f9] is only due to hyperventilation.

See the [Pathfinder User Guide](#) and [Pathfinder Technical Reference](#) for more details.

[Table 18](#) gives the mass and volume fractions of air and the gas mixture used for the incapacitation calculation. The FED was calculated for air and for the incapacitation case.

Table 18. Mass and Volume Fractions of Air and Incapacitation Calculation Mixture

Species	Air		Incapacitation Calculation	
	Mass Fraction	Vol Fraction	Mass Fraction	Vol Fraction
N2	7.630774E-01	7.835682E-01	8.270000E-01	8.420530E-01
O2	2.311814E-01	2.078229E-01	1.500000E-01	1.337080E-01
CO2	5.919362E-04	3.869034E-04	1.000000E-02	6.481168E-03
CO	0	0	5.000000E-03	5.091609E-03
H2O	5.149269E-03	8.222023E-03	8.000000E-03	1.266627E-02

7.7.2. Expected Results

The FED calculation for air should be approximately zero for all time. The FED calculation using the incapacitation gas mixture should increase linearly with time. The time at which FED is equal to one should match the hand calculation and the fire simulator calculation.

7.7.3. Results

At 300 seconds, the FED calculation for pure air was **0.001589**. The small non-zero value is due to the slight difference in default [stem adae461c37eccd2f2a6ed21ebf2c5d08] volume fraction assumed in FDS as compared to the value of 20.9 in the SFPE equations.

For the incapacitation calculation, FED = 1 was calculated to occur at 247.5 seconds. The hand calculation gives 247.4. The calculated result matches the expected result.

7.8. Elevator usage (Verif.2.7)

This test verifies the capability of evacuation models to simulate evacuation using elevators. A schematic of the geometry is shown in [Figure 152](#). The corresponding Pathfinder model is shown in [Figure 153](#).

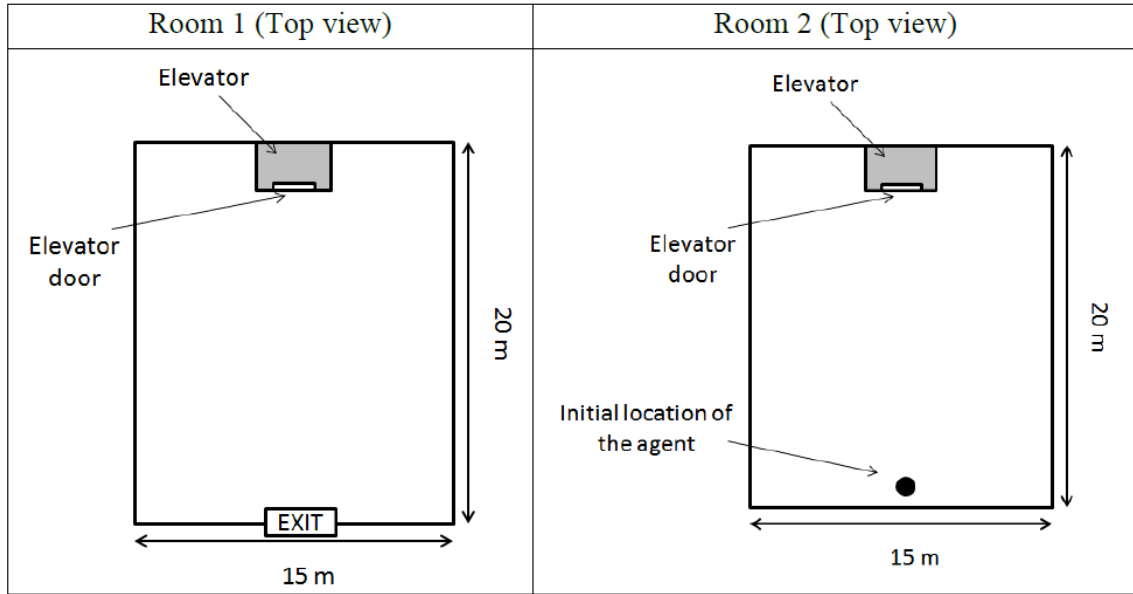

Figure 152. Geometry of elevator verification (Verif.2.7). Figure from NIST Technical Note 1822, 2013.

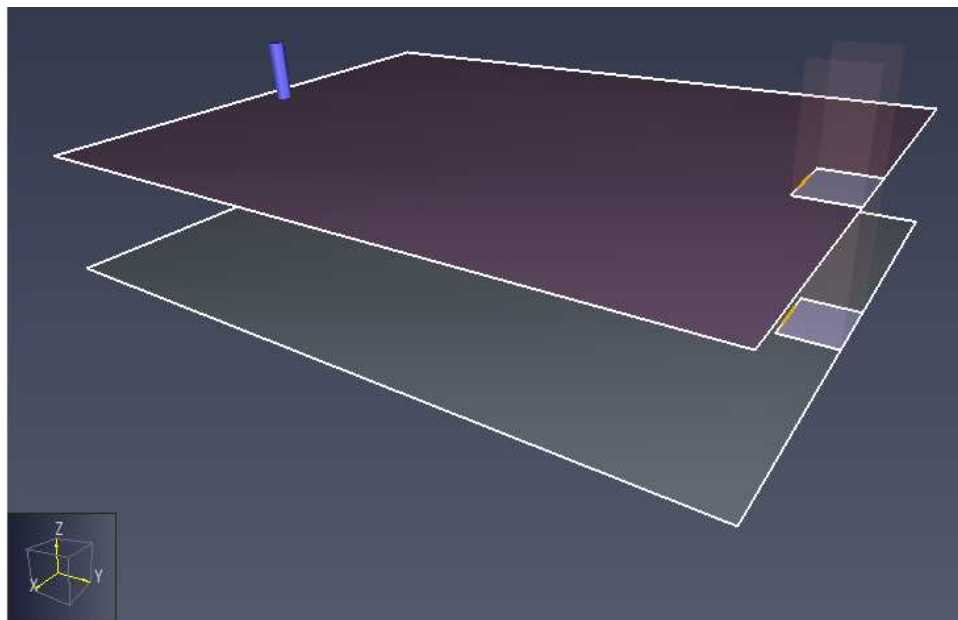

Figure 153. Pathfinder model of elevator verification

7.8.1. Setup Notes

Room 1 is located at $Z=0.0$ and Room 2 at $Z=3.5$ m. An elevator connects the two rooms in accordance with Figure 152. The Floor 1 exit door is 1 m wide. The elevator is called from Room 1, reaches Room 2 and carries the occupant and back to Room 1.

The occupant has an unimpeded walking speed of 1 m/s in Room 2 with an instant response time. To minimize inertia effects, the Acceleration Time was set to zero. To simplify distance

calculations, the occupant size was set to 50 cm. The initial distance between the center of the occupant and the elevator door is 17.5 m. However, since the occupant radius is 0.25 m and the distance from the elevator to activate a call is 0.5 m, the occupant walks 16.75 m to activate the call.

The elevator parameters include: door open and close times of 3.5 s, pickup and discharge travel times of 2.5 s between the two floors, and door open and close delays of 5.0 s. The open delay is the minimum time an elevator's door will stay open on a floor (does not impact this test case) and the close delay is the time the elevator door will remain open after the last person enters.

7.8.2. Expected Results

The occupant starts walking at time zero and the elevator is called from the discharge floor after the occupant has walked 16.75 m. Once called, the door must close on the discharge floor and then the elevator must move to the second floor. The door then opens, the occupant enters the elevator by moving the distance of the occupant radius away from the door (the occupant moves at about a 45° angle), there is a door close delay, and finally the door closes. The elevator then moves to the discharge floor, the door opens, and the occupant leaves the building. The total expected evacuation time is 60.60 s, shown in Table 19.

Table 19. Calculation of expected evacuation time

Evacuation Time		
Task	Calc	Cumulative Time
Start	0.0	0.0
Walk to Activate Elevator Call	16.75	16.75
Door Closes on Discharge Floor	3.50	20.25
Elevator Pickup Time	2.50	22.75
Door Open on Call Floor	3.50	26.25
Load Time	0.35	26.60
Door Close Delay Time	5.00	31.60
Door Close on Call Floor	3.50	35.10
Elevator Discharge Travel Time	2.50	37.60
Door Open on Discharge Floor	3.50	41.10
Building Exit Time	19.50	60.60

7.8.3. Results

The observed exit time is 60.5 s for SFPE mode. Identical results (within tolerance) were obtained for the Steering+SFPE and Steering modes.

All modes passed test criteria.

7.9. Horizontal counter-flows (Verif.2.8)

A modification of IMO Test 8, which has already been presented.

7.10. Group behaviors (Verif.2.9)

This test verifies movement in a group. A group (Zone 1) is defined where four members of the group have a walking speed of 1.25 m/s and one member a speed of 0.5 m/s. In Zone 2, individual occupants have an unimpeded speed of 0.2 m/s. All occupants proceed to the 1 m wide exit.

The geometry defined in the NIST document and the corresponding Pathfinder model are shown in [Figure 154](#) and [Figure 155](#). In the Pathfinder model, the blue and red occupants are in the group and the center occupant has the slow speed. The green occupants act as individuals.

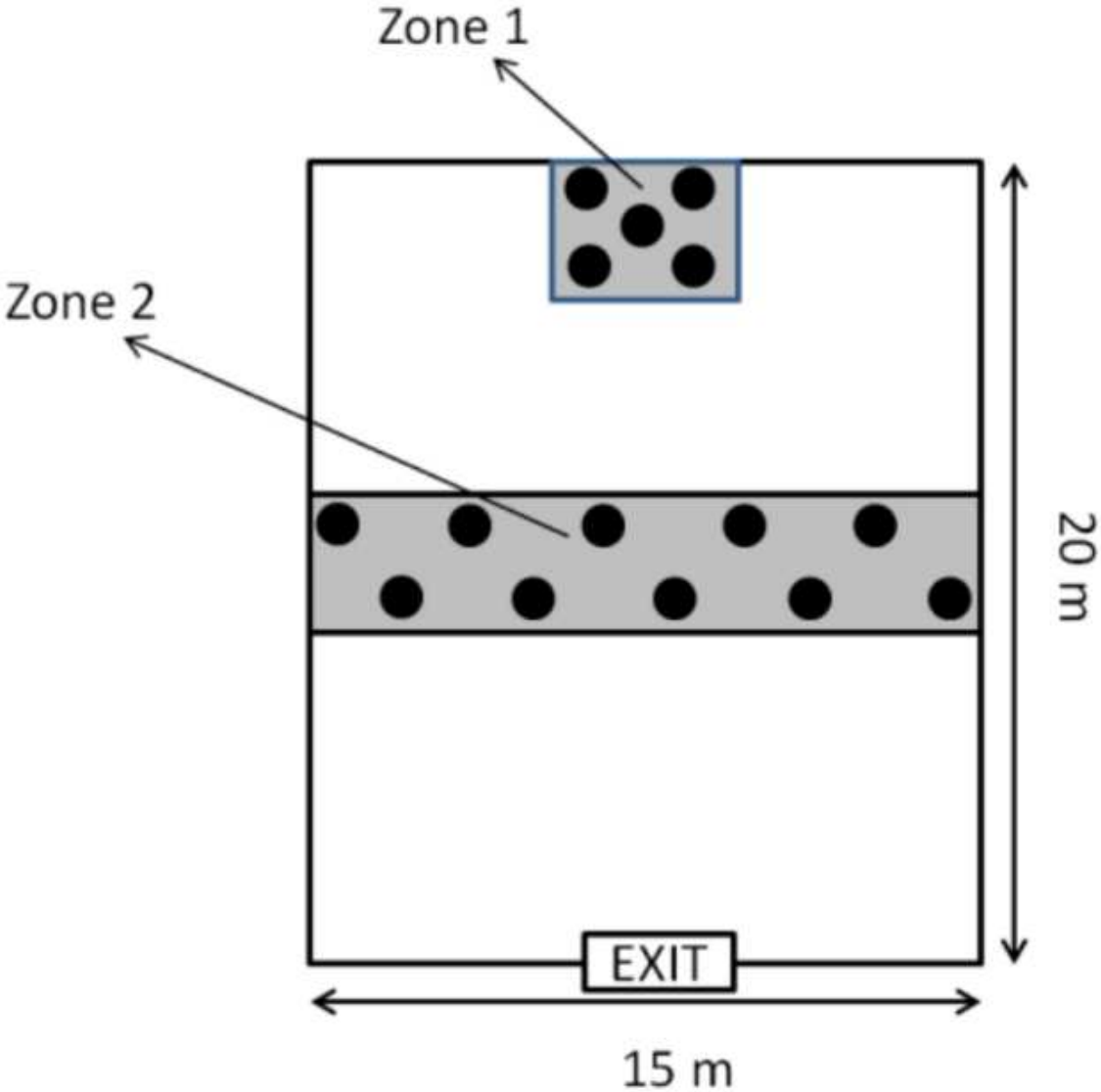

Figure 154. NIST Technical Note 1822, 2013.

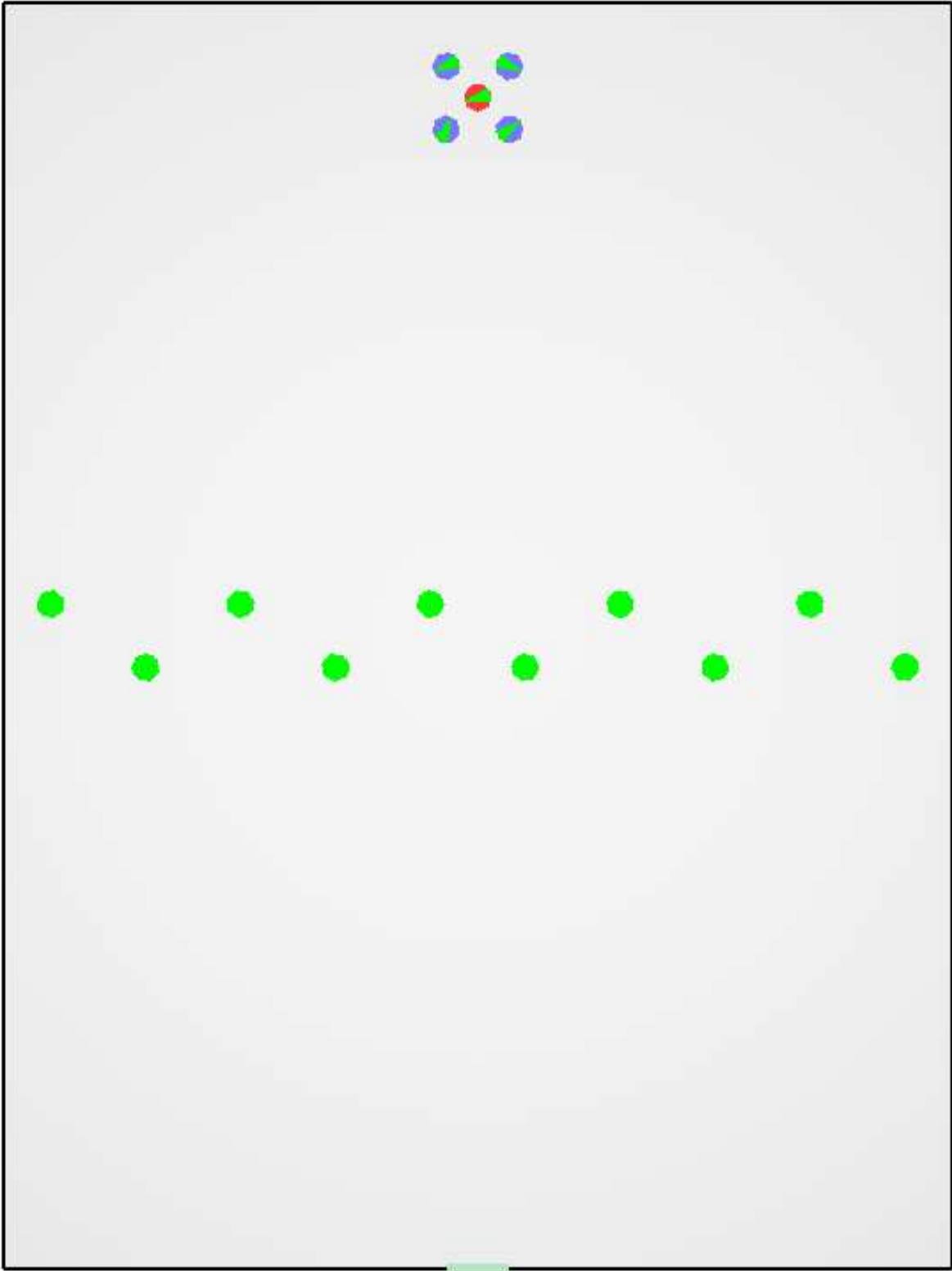

Figure 155. Pathfinder model

7.10.1. Setup Notes

Two parameters in Pathfinder control group behavior: Maximum Distance and Slowdown Time. Members of the group try to maintain a distance between themselves less than the maximum distance. If any member is separated by more than the maximum distance, the leading members slow down for an interval equal to the Slowdown Time. If the group has still not reformed after that time, then the leading members will stop and wait for the group to reform.

Results will be presented using the default Pathfinder parameters that define a relatively loose group, Maximum Distance = 2 m and Slowdown Time = 3 s.

Only results for steering mode are presented because steering+SFPE gives similar results. In SFPE mode occupants can overlap so, as expected, the group just proceeds through the slow occupants without interaction.

7.10.2. Expected Results

The group of five occupants should remain together and exit the door within a time frame of 10 seconds.

7.10.3. Results

Figure 156, Figure 157, and Figure 158 show a sequence of images for default grouping showing movement at 20 s, at 36.5 seconds when the first group member exits, and at 45 seconds when the last group member exits. The time interval for the group to exit is 8.5 seconds.

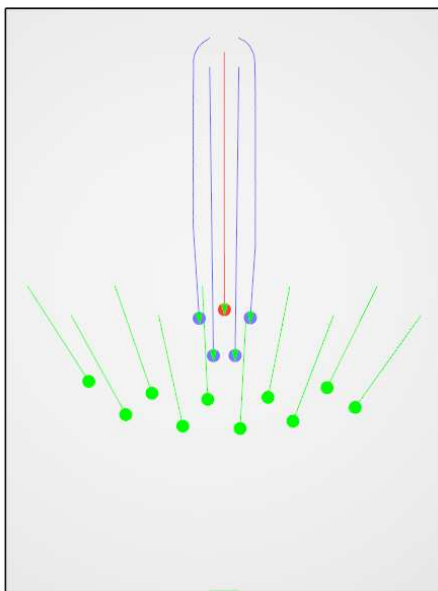

Figure 156. 20 seconds

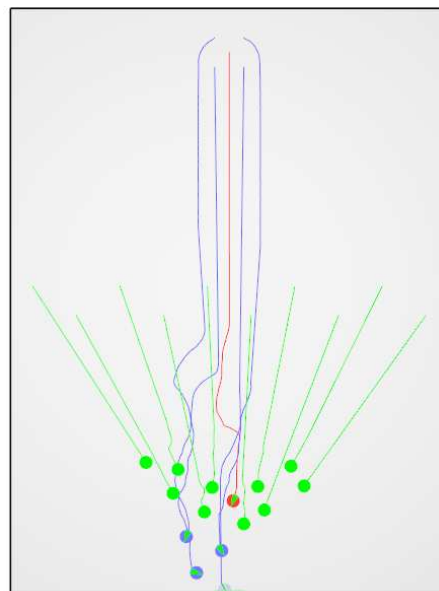

Figure 157. 36.5 seconds first group exit

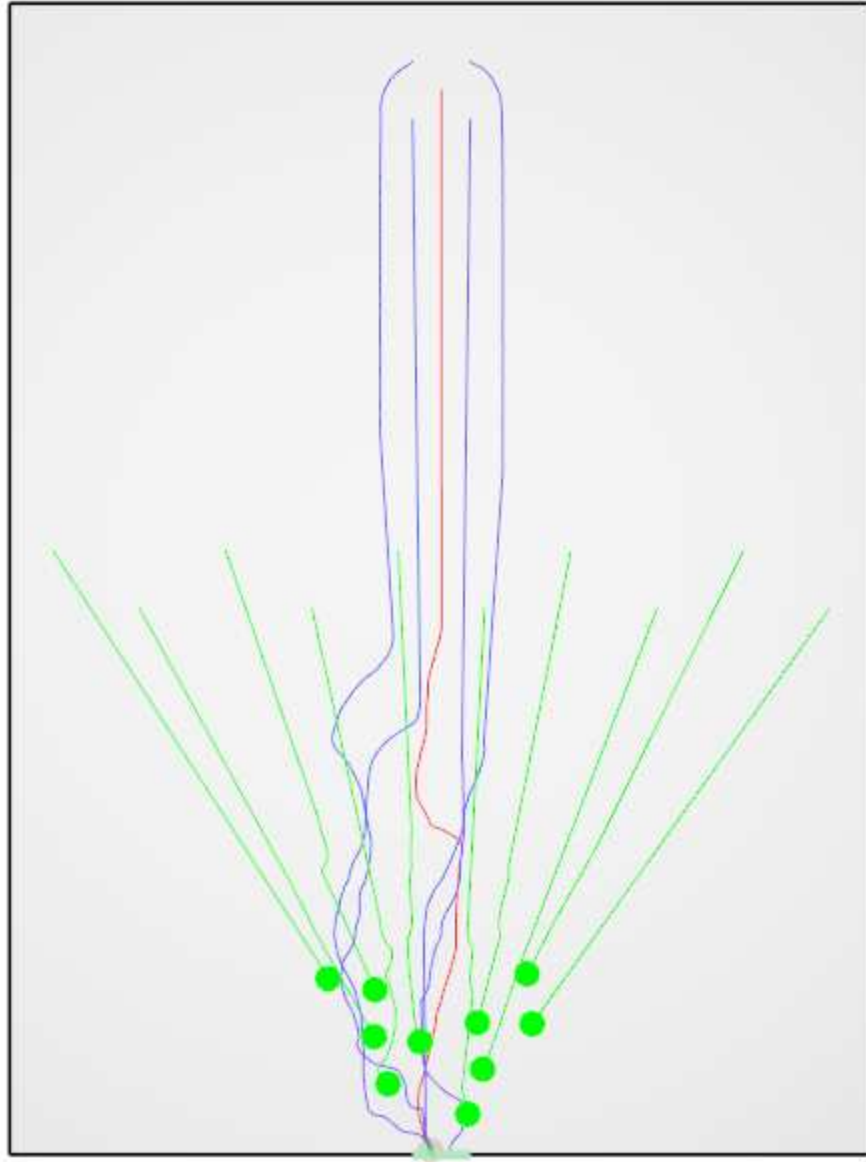

Figure 158. 45 seconds last group exit

7.11. People with movement disabilities (Verif.2.10)

This test is designed for the verification of emerging behaviors of people with disabilities. It tests the possibility of simulating an occupant with reduced mobility (e.g. decreased travel speeds and increased space occupied by the occupants) as well as representing the interactions between impaired individuals and the rest of the population and the environment.

Construct two rooms at different heights, namely room 1 (1 m above the ground level) and room 2 (at ground level), connected by a ramp (or a corridor/stair if the model does not represent ramps).

Insert one exit (1 m wide) at the end of room 2.

Scenario 1: Room 1 is populated with a sub-population consisting of 24 occupants in zone 1 (with an unimpeded walking speed of 1.25 m/s and the default body size assumed by the model) and 1 disabled occupant in zone 2 (the occupant is assumed to have an unimpeded walking speed equal to 0.8 m/s on horizontal surfaces and 0.4 on the ramp. The disabled occupant is also assumed to occupy an area bigger than half the width of the ramp (>0.75 m). All occupants must reach the exit in room 2.

Scenario 2: Re-run the test and populate zone 2 with an occupant having the same characteristics of the other 24 occupants in zone 1 (i.e. no disabled occupants are simulated). All occupants must reach the exit in room 2.

A schematic of the geometry is shown in Figure 159. The corresponding Pathfinder model is shown in Figure 160.

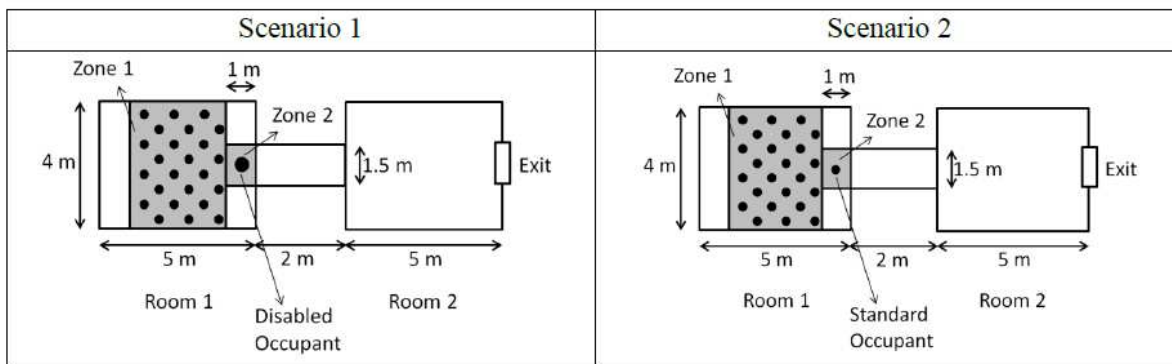

Figure 159. Geometry of movement disabilities verification (Verif.2.10). Figure from NIST Technical Note 1822, 2013.

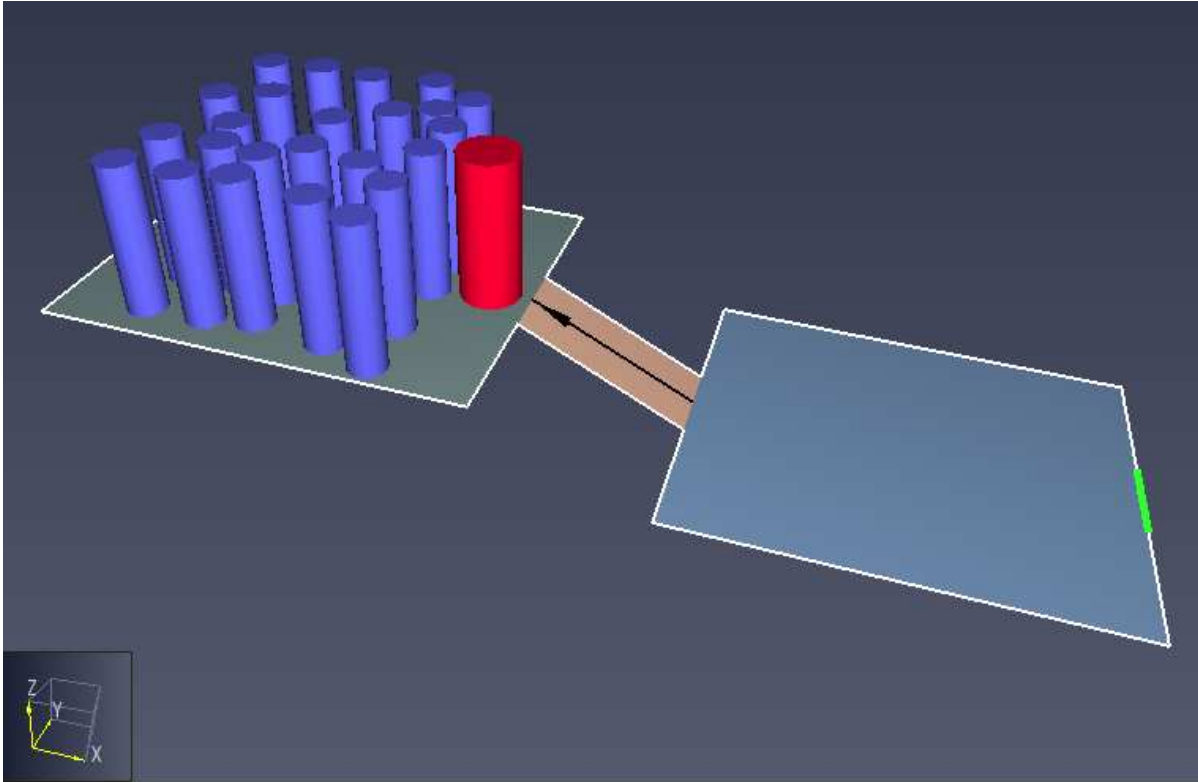

Figure 160. Pathfinder model of movement with disabilities. Red occupant has disabilities.

7.11.1. Setup Notes

The room geometry is setup as defined. The shoulder width of the 24 occupants is 45.58 cm and of the disabled person 75 cm. The walking speed of the 24 occupants is Room 1 is 1.25 m/s and the walking speed of the disabled person was defined as 0.8 m/s. The disabled occupant was given a ramp speed was 0.4 m/s with other occupants walking the same speed on the ramp and level.

The SFPE and Steering+SFPE calculations included a 15 cm boundary layer.

7.11.2. Expected Results

All occupants will reach the exit. Scenario 1 will have a longer evacuation time than scenario 2.

7.11.3. Results

Table 20 shows the time to evacuate all occupants. The disabled occupant did slow the evacuation slightly by blocking flow on the ramp, but after leaving the ramp the faster occupants moved around the disabled occupant, so the slowing effect was reduced, Figure 161 and Figure 162.

Table 20. Times to evacuate all occupants

Mode	Scenario 1 (s)	Scenario 2 (s)
Steering	44.58	33.62
Steering + SFPE	48.42	40.80
SFPE	36.10	32.70

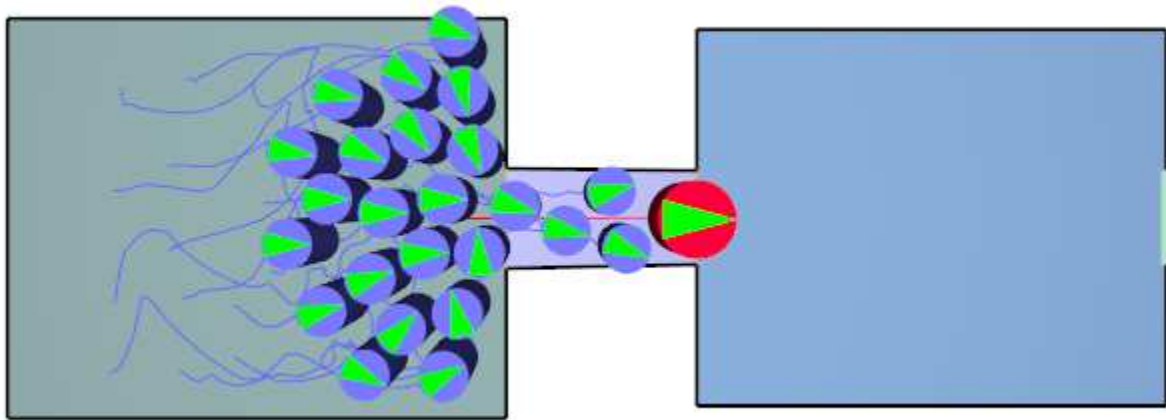

Figure 161. Steering mode showing disabled occupant blocking flow on ramp. Lines show paths.

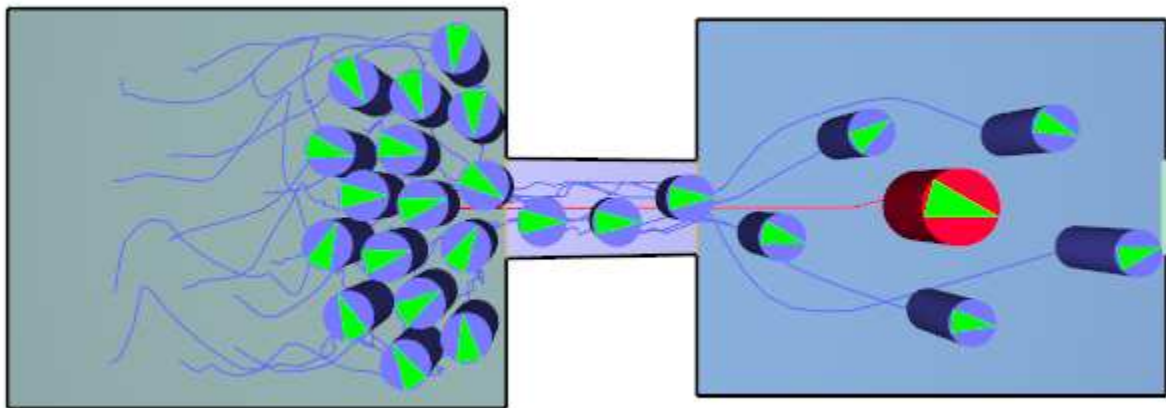

Figure 162. Steering mode showing how faster occupants move around disabled occupant past ramp. Lines show paths.

7.12. Exit route allocation (Verif.3.1)

A modification of IMO Test 10, which has already been presented.

7.13. Social influence (Verif.3.2)

The current version of Pathfinder does not use social influence, so this verification test is not applicable.

7.14. Affiliation (Verif.3.3)

The current version of Pathfinder does not use social affiliation, so this verification test is not applicable.

7.15. Dynamic availability of exits (Verif.4.1)

This test is aimed at qualitatively evaluating the capabilities of the model to represent the dynamic availability of exits.

Construct a room of size 10 m by 15 m. Two exits (1 m wide) are available on the 15 m walls of the room and they are equally distant from the 10 m long wall at the end of the room (see [Figure 163](#)).

Insert an occupant in the room with a response time equal to 0 and a constant walking speed equal to 1 m/s as shown in [Figure 163](#). Exit 1 becomes unavailable after 1 s of simulation time. Check the exit usage for both Exit 1 and Exit 2.

A schematic of the geometry is shown in [Figure 163](#).

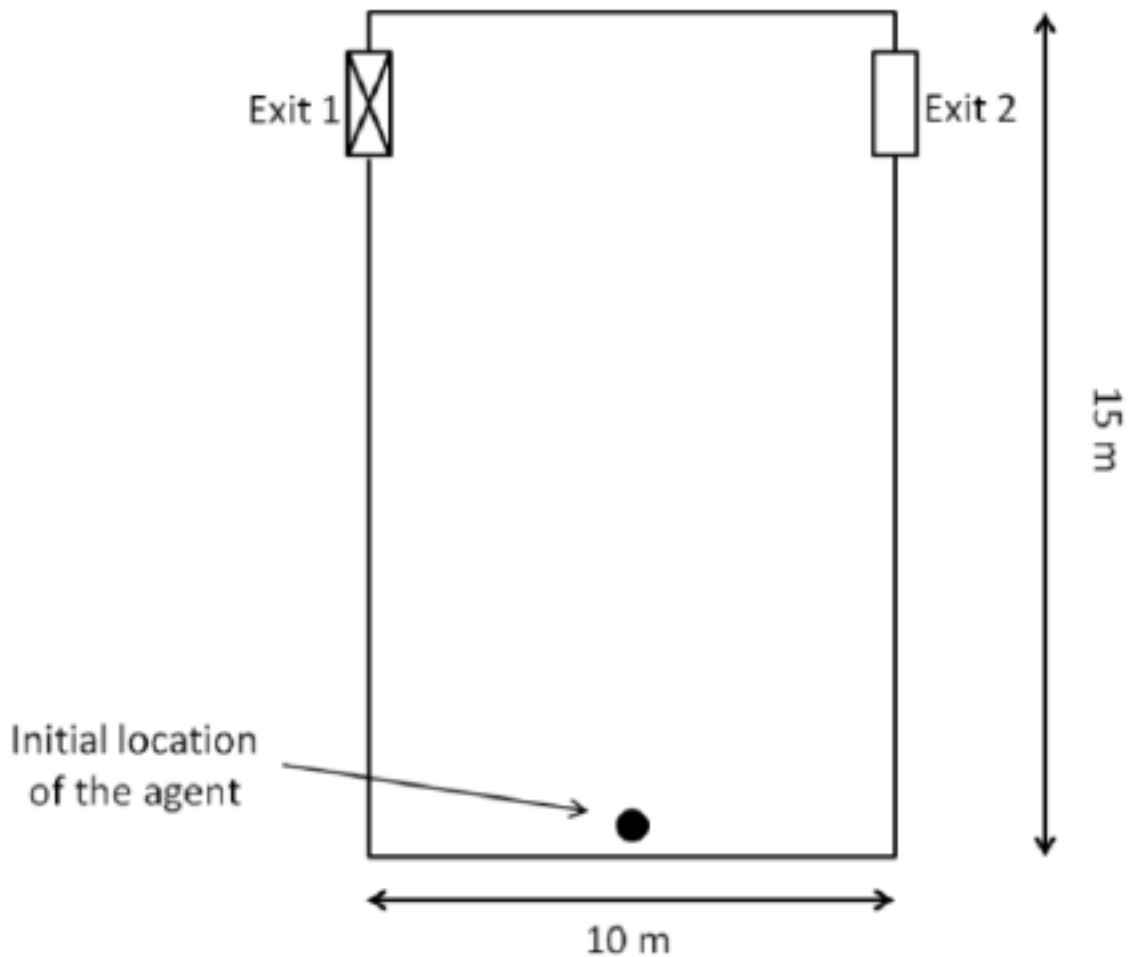

Figure 163. Geometry for dynamic availability of exits (Verif.4.1). Figure from NIST Technical Note 1822, 2013.

7.15.1. Setup Notes

The room geometry is setup as defined. Pathfinder uses a "locally quickest" algorithm to select the exit door from a room. To ensure that the occupant selects Exit 1, the occupant was located at $X=4.5$ m or $X=0.5$ m closer in the X direction to Exit 1.

7.15.2. Expected Results

The occupant will initially select Exit 1, then at 1.0 s will change to Exit 2.

7.15.3. Results

Figure 164 shows path used by the occupant. At 1.0 s, the occupant changes from Exit 1 to Exit 2. The same result was obtained for Steering+SFPE and SFPE modes.

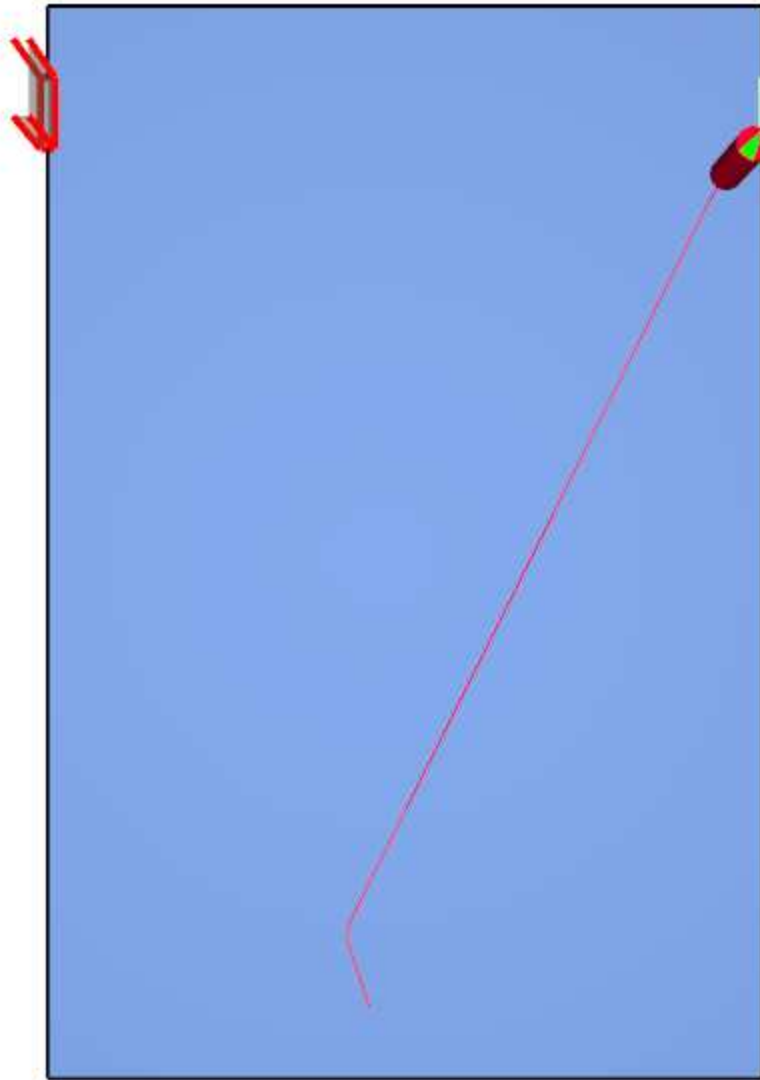

Figure 164. Change in exit selection at 1.0 s. Line shows path. Steering mode.

7.16. Congestion (Verif.5.1)

A modification of IMO Test 11, which has already been presented.

7.17. Maximum flow rates (Verif.5.2)

A modification of IMO Test 4, which has already been presented.

Chapter 8. SFPE Example Problems

This section presents Pathfinder results for models based on example problems given for the hand calculations presented in the Engineering Guide for Human Behavior in Fire (SFPE 2019).

8.1. Example 1: Single Room and Stairway (SFPE_1)

This is a verification test for SFPE-based simulation results. This example reproduces Example 1 given in the SFPE Engineering Guide. In this example, 300 occupants are initially positioned in a room of unspecified geometry. The occupants egress through two 32 inch doors that lead to two enclosed 44 inch stairs. The room is connected (directly) to two 44 in wide stairways via two 32 in doors. The occupants must move through the doors and down the 7 x 11 inch (height and depth), 50 ft long stairs. After reaching the base of the stairway, the occupants exit the model through a 30 ft x 6 ft room. The problem specifies that the maximum travel distance between an occupant's initial position and the nearest door leading to a stairway is 200 ft. This test will assume the initial room is a 200 ft x 30 ft room with both stairways positioned on one of the 30 ft walls [Figure 165](#). The small room is 6 ft x 30 ft with an exit spanning the wall opposite the stairs.

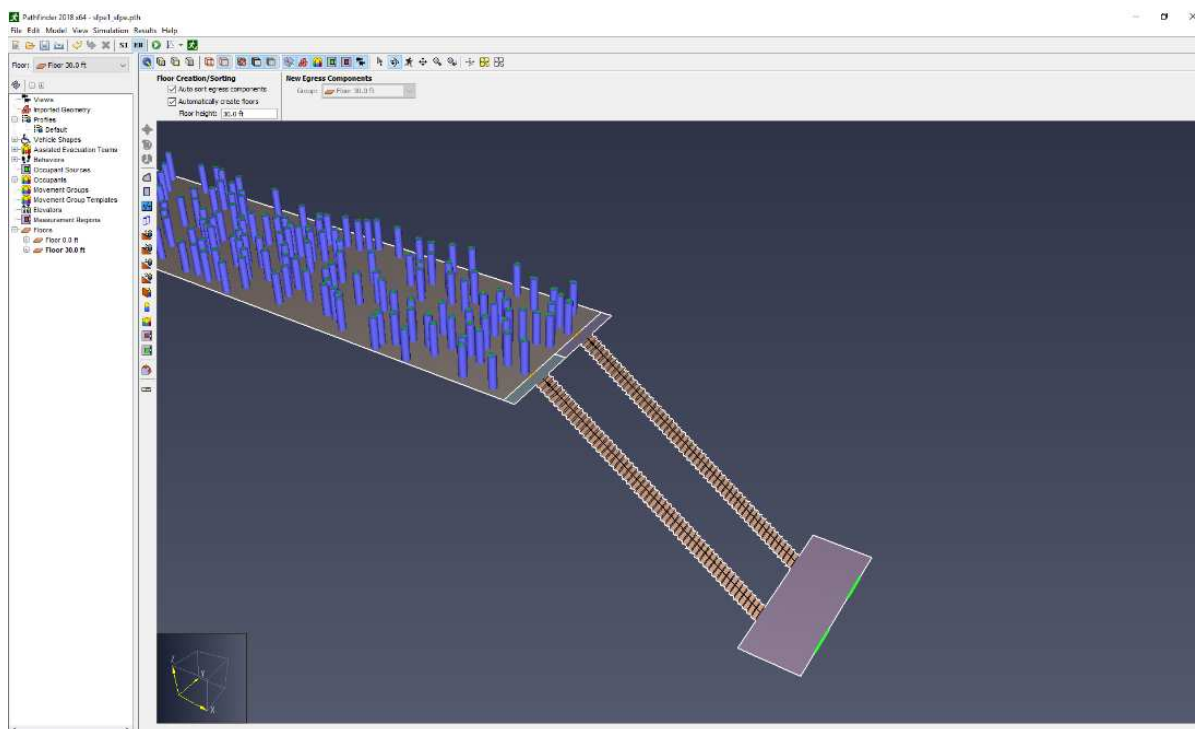

Figure 165. Initial configuration for SFPE 1.

8.1.1. Setup Notes

The door boundary layer is specified as 6 in.

8.1.2. Expected Results

In this example, the door entering each stairway is the controlling component. The problem is symmetrical so, for the hand calculation, the divided flow can be modeled as a single wide door and stairway. To calculate the total movement time, we must calculate [stem afb58a12826fe5dc493789f34696688e] where: ([stem f2feace4795d36141f23db1b75d8bd50]) is the time it takes the first occupant to reach the controlling component, ([stem 114aef2d39f6bf9f78060adfa45fcbc2]) the time it takes 300 occupants to flow through two 32-inch doors, and ([stem 29b1a8c48228115b4468ab870548dfbd]) the time it takes the last occupant to move from the controlling component to the exit.

The value of [stem f2feace4795d36141f23db1b75d8bd50] depends on the location of the occupants. For this model, the value is approximately [stem 30f02788e4476760d2c7e549a4437b83].

The time needed for 300 occupants to pass through the two 32 inch doors, [stem 114aef2d39f6bf9f78060adfa45fcbc2] is:

$$[T_2] = \frac{P}{F_{s_{\max}} W_e} = \frac{300 \text{ pers}}{24 \frac{\text{pers}}{\text{min}}}$$

$$2 \left(32 \text{ in} - 2(6 \text{ in}) \right) \times \frac{1 \text{ ft}}{12 \text{ in}} =$$

$\mathbf{3.75} \mathbf{\min} \mathbf{=} \mathbf{225.0 \ s}$ |

../../../../../../../../includes/images/stem-f5d44bb49da6e7af89f8243298fe06e6.png

The time needed for the last occupant to move down the stairs and out the landing, [stem 29b1a8c48228115b4468ab870548dfbd] is:

$$[T_3] = \frac{d}{v} = \frac{50 \text{ ft}}{0.85 \times 212 \frac{\text{ft}}{\text{min}}} \approx 60 \frac{\text{s}}{\text{min}}$$

$$\text{right) + } \frac{10 \text{ ft}}{3.9 \frac{\text{ft}}{\text{s}}} = \mathbf{19.2 \text{ s}}$$

../../../../../../../../includes/images/stem-eb3e6f1972a59e8c7c2088ee541fcf93.png

The total evacuation time, [stem 724076666782884bc9e6a0d1a0b4007d] is:

$$[T_{\text{total}} = T_1 + T_2 + T_3 = \mathbf{245.2\ s}] |$$

../../../../../../../../includes/images/stem-1ac31cc6082db5eca3f2c72c93b8d187.png

8.1.3. Results

For each simulation mode, [Table 21](#) lists the number of people that used each stair and the total evacuation time. Because the number of people that use the left and right exits are not equal, we present the times for each side.

Table 21. Number of people that used each stair and total evacuation times.

Mode	Total Persons - Left	Total Persons - Right	Evacuation Time - Left (s)	Evacuation Time - Right (s)
Steering	152	148	238.07	236.40
Steering + SFPE	152	148	273.48	274.93
SFPE	148	152	239.22	245.18

8.1.4. Analysis

All cases show satisfactory comparison with the expected result.

8.2. Example 2: 5-Story Building (SFPE_2)

This is a verification test for SFPE-based simulation results. This example reproduces Example 2 given in the SFPE Engineering Guide, ([SFPE 2019](#)). In this example, we have a 5-story building. Each floor is served by two 44 inch stairways. The stairs have a 7 inch rise and an 11 inch run. The stairways have hand-rails on both sides 2.5 inches from the wall. Each stairway connects to a 4 ft x 8 ft platform located between the level of the floors. The distance between the floors is 12 ft. The stairways connect to the floors with 32 inch doors. There are 200 people on each floor. [Figure 166](#) shows the problem setup.

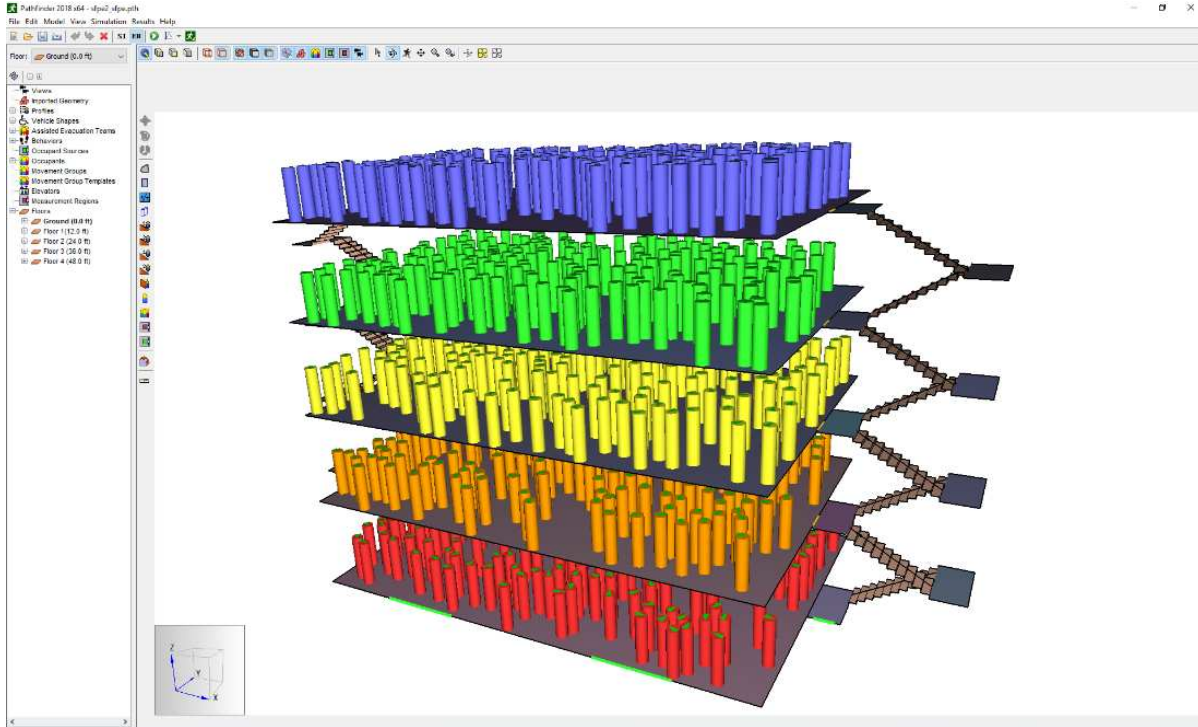

Figure 166. SFPE Example 2 Problem Setup

8.2.1. Setup Notes

Detailed setup notes are presented in the Pathfinder example guide.

Following the intention of the problem, all occupants of the ground floor exit from four large side doors and all occupants on higher floors exits from doors at the base of the stairs.

A second steering mode case was run where occupants had an increased preference to remain in their current door queue (**Current Door Preference** parameter of the **Profile**). This parameter was changed from the default 35% to 80%.

8.2.2. Expected Results

In this example, the controlling component is the exit door at the base of the stairway. We will assume the occupants use the stairways evenly, in which case we only need to model the time it takes for half the occupants on the second through fifth floors to pass through the controlling 32 inch door.

To calculate the total movement time, we must calculate t_{stem} where:

- (t_{stem}) is the time it takes the first occupant to reach the controlling component.

- ([stem 114aef2d39f6bf9f78060adfa45fcbc2]) is the time it takes 400 occupants to flow through the controlling component (a 32 in door).
- ([stem 29b1a8c48228115b4468ab870548dfbd]) is the time it takes for the last occupant to move from the controlling component to the exit.

The calculation for T1 has four parts:

- ([stem 8b4a231f101a699bde84f87c8fc38f6e]) is the time it takes the occupant nearest the door on the second floor to travel from their initial location to the stairway entrance,
- ([stem 73747e251a80120409188dc976ccc6c5]) is the time to move down the stairs to the platform,
- ([stem de0b14759ff3dab147910ef235d5bd32]) is the time to walk across the platform, and
- ([stem c95b2043c80ea64d8b56e1b8e269242e]) is the time to move down the stairs to the door.

We assume a low-density velocity calculation for the first occupant to reach the stairs and the landing. For [stem 8b4a231f101a699bde84f87c8fc38f6e] we assume the person must walk 6 ft to reach the center of the stairs. For [stem 73747e251a80120409188dc976ccc6c5] we will assume the occupant must walk 8 ft, an average length of travel, to traverse the platform. This leads to the following calculations:

$$[v_{\text{level}}] = 0.85 \times 1.40 \frac{\text{m}}{\text{s}} = 1.19 \frac{\text{m}}{\text{s}} \quad |$$

../../../../../../../../includes/images/stem-ec58dde812c3d6d7ff3898c8c90dd953.png

$$[v_{\text{stair}} = 0.85 \times 1.08 \frac{m}{s} = 0.92 \frac{m}{s}] |$$

../../../../../../../../includes/images/stem-1c855edaedba39bba77f2a2b158c73b1.png

$$T_A = \frac{d}{v_{\text{level}}} = \frac{6 \text{ ft}}{\left(\frac{0.3048 \text{ m}}{\text{ft}} \right)} \{1.19 \text{ s}\}$$

`\frac{m}{s}} = \mathbf{1.5\ s}} | ../../../../includes/images/stem-`

5156ce5e35095e56b7fe37f35f0a283a.png

$$[T_B + T_D] = 2 \left(\frac{d}{v_{\text{stair}}} \right) = 2 \left(\frac{11.17 \text{ ft}}{0.92 \frac{\text{m}}{\text{s}}} \right)$$

$$\left(\frac{0.3048 \text{ m}}{\text{ft}}\right) = \mathbf{7.4 \text{ s}}$$

../../../../../../../../includes/images/stem-45ce1c93c923e891dbc510792345f3a6.png

$$T_C = \frac{d}{v_{\text{level}}} = \frac{8 \text{ ft}}{\left(\frac{0.3048 \text{ m}}{\text{ft}} \right)} \{1.19 \text{ s}\}$$

`\frac{m}{s}} = \mathbf{2.0\ s}} | ../../../../includes/images/stem-`

1439ce216027b66004a59bf56fe9320b.png

$$[T_1 = T_A + T_B + T_C + T_D = 1.5\text{ s} + 7.4\text{ s} + 2.0\text{ s} = \mathbf{10.9\text{ s}}] |$$

../../../../../../../../includes/images/stem-1be95a21d4270f73128a9837333eb0a6.png

The time for 400 people to move through a 32 inch door, [stem 114aef2d39f6bf9f78060adfa45fcbc2] is:

$$[T_2 = \frac{P}{F_{s_{\max}} W_e} = \frac{400 \text{ pers}}{1.32 \frac{\text{pers}}{\text{m} \cdot \text{s}} \times$$

$\left\lfloor 32 \right\rfloor - 2 \left(6 \right) \left\rfloor \times \frac{\text{ft}}{12} \times \frac{0.3048}{\text{ft}}$

$m\{\text{text}\{\text{ft}\}\} = \mathbf{596.5\ s}$ | ../../../.././includes/images/stem-

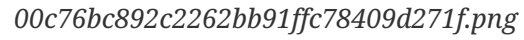

The time for the last person to move from the stairs to the exit is:

$$T_3 = \frac{d}{v_{\text{level}}} = \frac{4 \text{ ft}}{\left(\frac{0.3048 \text{ m}}{\text{ft}} \right)} = 1.19$$

`\frac{m}{s}} = \mathbf{1.0\ s}} | ../../../../includes/images/stem-`

4d3294cb73d6e07d03136a936663cd18.png

The total evacuation time, [stem 724076666782884bc9e6a0d1a0b4007d] is:

$$[T_{\text{total}} = T_1 + T_2 + T_3 = 10.9\text{ s} + 596.5\text{ s} + 1.0\text{ s} = \mathbf{608.4\text{ s}}] |$$

Bibliography

“ISO 16730-1:2015(E) - Fire Safety Engineering — Procedures and Requirements for Verification and Validation of Calculation Methods.” 2015. International Organization for Standardization.

“IEEE 1012-2016 - IEEE Standard for System, Software, and Hardware Verification and Validation.” 2016. Institute of Electrical and Electronics Engineers.

Averill, Jason D., Dennis S. Mileti, Richard D. Peacock, Erica D. Kuligowski, Norman Groner, Guylene Proulx, Paul A. Reneke, and Harold E. Nelson. 2005. “Occupant Behavior, Egress, and Emergency Communication. Federal Building and Fire Safety Investigation of the World Trade Center Disaster (NIST NCSTAR 1-7).” National Construction Safety Team Act Reports (NCSTAR). National Institute of Standards and Technology, Gaithersburg, Maryland, USA.

<https://www.nist.gov/publications/occupant-behavior-egress-and-emergency-communication-federal-building-and-fire-safety-0>.

Boyce, K.E., David Purser, and T. Shields. 2012. “Experimental Studies to Investigate Merging Behaviour in a Staircase.” *Fire and Materials* 36 (August). <https://doi.org/10.1002/fam.1091>.

Fridolf, Karl, Enrico Ronchi, Daniel Nilsson, and Håkan Frantzich. 2019. “The Representation of Evacuation Movement in Smoke- Filled Underground Transportation Systems.” *Tunnelling and Underground Space Technology* 90 (April): 28–41. <https://doi.org/10.1016/j.tust.2019.04.016>.

Galea, E.R., G. Sharp, and P.J. Lawrence. 2008. “Investigating the Representation of Merging Behavior at the Floor—Stair Interface in Computer Simulations of Multi-Floor Building Evacuations.” *Journal of Fire Protection Engineering* 18 (4): 291–316. <https://doi.org/10.1177/1042391508095092>.

Hunt, Aoife, Edwin R. Galea, and Peter J. Lawrence. 2013. “An Analysis and Numerical Simulation of the Performance of Trained Hospital Staff Using Movement Assist Devices to Evacuate People with Reduced Mobility.” *Fire and Materials* 39 (4): 407–29. <https://doi.org/10.1002/fam.2215>.

IMO. 2016. “IMO Guidelines for Evacuation Analysis for New and Existing Passenger Ships. MSC.1/Circ.1533.” 4 Albert Embankment, London, Great Britain: International Maritime Organization.

Klote, J. H., and D. M. Alvord. 1992. “Feasibility and Design Considerations of Emergency Evacuation by Elevators.” NISTIR. National Institute of Standards and Technology, Gaithersburg, Maryland, USA, and George Mason University, Fairfax, Virginia, USA. <http://bit.ly/3aOfSiJ>.

Korhonen, Timo. 2018. *Fire Dynamics Simulator with Evacuation: FDS+Evac, Technical Reference and User’s Guide*. Sixth Edition. VTT Technical Research Centre of Finland: VTT. http://virtual.vtt.fi/virtual/proj6/fdsevac/documents/FDS+EVAC_Guide.pdf.

SFPE. 2016. *SFPE Handbook of Fire Protection Engineering*. 5th ed. Springer-Verlag New York. <https://www.springer.com/us/book/9781493925643>.

———. 2019. *SFPE Guide to Human Behavior in Fire*. 2nd ed. Springer International Publishing. <https://www.springer.com/gp/book/9783319946962>.

Zhang, J, W Klingsch, A Schadschneider, and A Seyfried. 2011. “Transitions in Pedestrian Fundamental Diagrams of Straight Corridors and T-Junctions.” *Journal of Statistical Mechanics: Theory and Experiment* 2011 (06): P06004. <https://doi.org/10.1088/1742-5468/2011/06/p06004>.

Zhang, Jun, Wolfram Klingsch, Tobias Rupperecht, Andreas Schadschneider, and Armin Seyfried. 2011. “Empirical Study of Turning and Merging of Pedestrian Streams in T-Junction.”

Zhang, Jun, Wolfram Klingsch, Andreas Schadschneider, and Armin Seyfried. 2011. “Ordering in Bidirectional Pedestrian Flows and Its Influence on the Fundamental Diagram.”

Zhang, Jun, and Armin Seyfried. 2013. “Empirical Characteristics of Different Types of Pedestrian Streams.” *Procedia Engineering* 62: 655–62. <https://doi.org/10.1016/j.proeng.2013.08.111>.